

IHDEDENTAL 

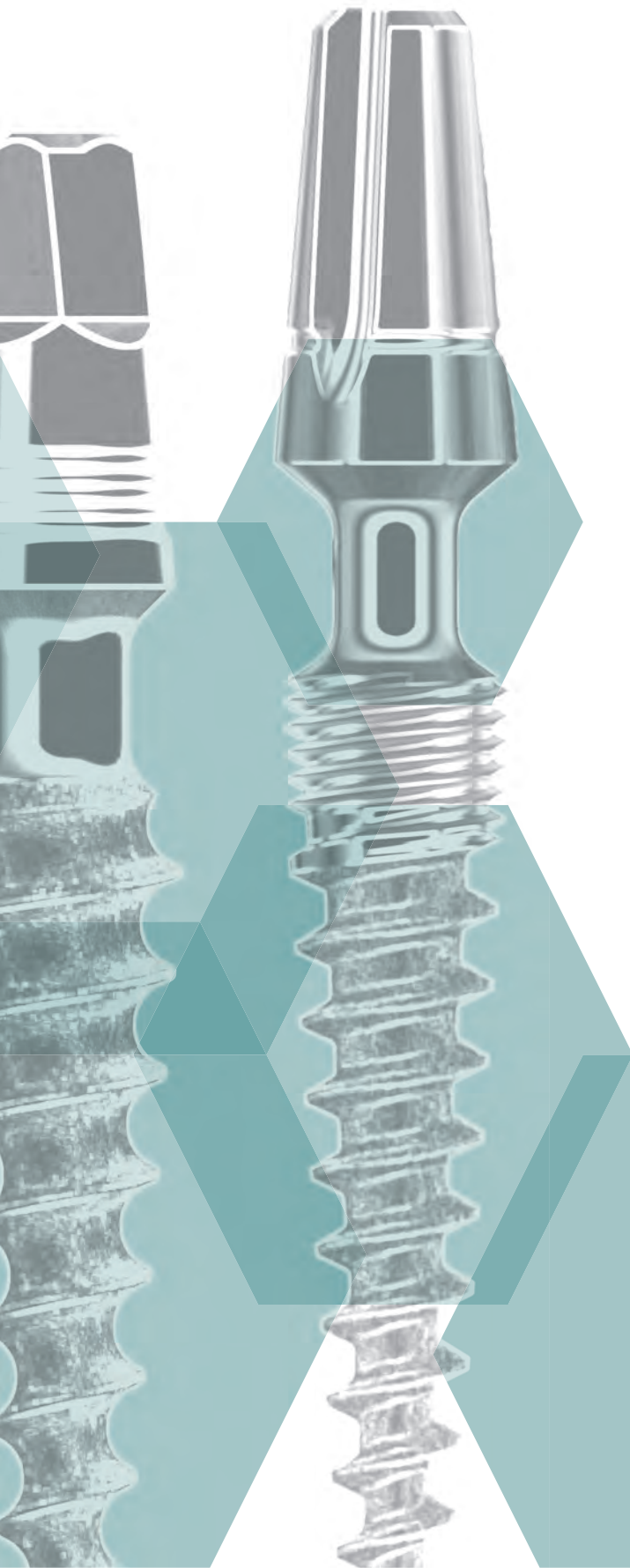

SINGLE PART IMPLANTS **IMMEDIATE LOADING
DENTAL IMPLANT
SYSTEM**
KOS[®]

Company building and production site of
Dr. Ihde Dental AG in Gommiswald / Switzerland



YOUR DEMAND IS OUR DRIVE

Dr. Ihde Dental has been a reliable partner for over 60 years providing a wide range of implant systems and consumables. We supply dentists and dental technicians with precisely coordinated materials and systems, which are easy and reliable to use. We always ensure high quality and an excellent price-performance ratio so that you can guarantee allround treatment for your patients that is cost-effective and highly efficient. The following catalog gives you an overview and all the essential information about our implant systems. You can also contact us personally any time using the phone numbers provided. Further information can be found on our websites:

www.ihde.com || www.ihde-dental.de || www.ihde.com

The company was founded in 1954 in Berlin by the dental technician Klaus Ihde. The company relocated to Bavaria in the 1960s. At the end of the 1980s, Dr. Ihde Dental GmbH (Germany) and Dr. Ihde Dental AG (Switzerland) were formed from the Klaus Ihde retail company. Ihde Dental is now represented in four locations in Europe and over 45 countries. The company group is one of the most innovative implant companies in the world – based on new developments and patents issued or pending.

The core activities of Ihde Dental are the development, procurement and distribution of medical products. We use a large number of suppliers in consumables, but we have produced implants in our own factory for many years. All components are manufactured quickly, precisely and economically thanks to state-of-the-art production technology and well-equipped machinery.

Our partners

Users and customers provide us with many new ideas and excellent suggestions. Collaboration with our customers is extremely important to us. Contact us at any time if you have any improvements or questions. Your ideas and opinions help us all to meet the daily wishes of patients to a greater and better extent. We also put the needs of the patient first..

Our market performance and work ethic

Since it was founded, the company has focused on innovative ideas and advanced technology, premium quality, an excellent price-performance ratio, optimal patient and user friendly products and durability. Our range combines the latest findings from research and practices in many countries around the world.

Customer orientated to us means – **available for you!**

- We provide training courses, refresher courses and user advice.
- We provide customers with comprehensive and technically sound advice.
- We also visit you in your practice upon request.

**Please call us to arrange an appointment
or send us an email.**

IHDEDENTAL 

Dr. Ihde Dental AG
Dorfplatz 11
CH - 8737 Gommiswald / SG
Tel. +41 (0)55 293 23 23
contact@implant.com

Dr. Ihde Dental GmbH
Erfurter Str. 19
D - 85386 Eching / Munich
Tel. +49 (0)89 319 761-0
Fax +49 (0)89 319 761-33
info@ihde-dental.de

“FOR ME, IMPLANTOLOGY BEGINS
WHERE OTHERS HAVE GIVEN UP.”

- Dr. Stefan Ihde



CONTENT

KOS® implants	6	Insertion tools	39
NO-ITIS® LASER – The new surface generation	7	Handgrip	40
KOS® instruction for application	10	Handgrip tray	41
KOS® Classic and Classic X implants	19	Instrument tray for KOS® and BCS®	42
KOS® B implants with small head for bridges	22	Drillstop tray	43
Impression taking and laboratory accessories	24	Starter tray	43
KDS bone expanding screws	26	KOS® implantations	44
KOS® PLUS implants	27	KOS® M and Micro implants	45
Example of use of KOS® Plus implants	29	Material / functionality / drilling procedure / insertion	46
KOS® TX implants	30	KOS® M implants with small abutment head	47
Insertion tools	32	KOS® Micro implants with large abutment head	49
Impression taking and laboratory accessories	32	Impression taking and laboratory accessories	50
KOS® Multi-Unit implants	33	Scanbodies	51
Accessories KOS® Multi-Unit implants	35	Instruments and tools	52
Application of KOS® Multi-Unit implants	36	Overview drilling depth and max. working length	53
KOS® K implants	37	Reprocessing of tools and drills	54

APPLICATION AREAS OF THE ENDOSSEOUS DENTAL IMPLANT SYSTEM **KOS**[®]

Suitable for crowns, bridges and bars. With the correct surgical procedure and good bone quality, the compression screws design permits to incorporate the restoration in an immediate loading protocol (incorporation of the prosthesis within a maximum of three days). Today, **KOS**[®] implants are routinely used for immediately loaded bridge constructions. The single-piece design saves costs, effort and prevents the problem of screw loosening. In extraction cases, **KOS**[®] and **BCS**[®] are combined.

The prescribed or recommended tightening torques for implants, abutments and screws can be found on our website:

www.implant.com/en/downloads

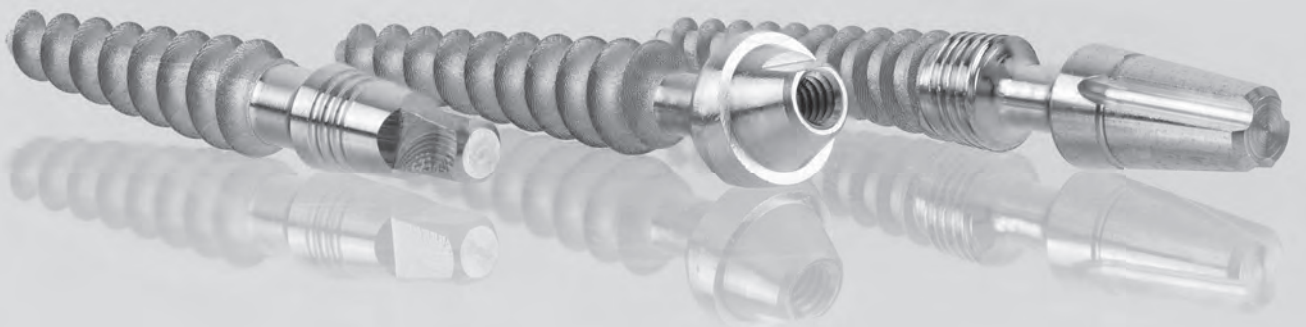

No-Itis® LASER – THE NEW SURFACE GENERATION

The new surface treatment for Dr. Ihde Dental AG implants is created with the latest generation of robotic tools for laser ablation. This new technology of high precision creates roughness in the implant through a mesh of hemispherical micrometric pores, with a defined, always identical size and shape and with a symmetrical distribution.

The result is a more adequate topography, which provides the most suitable conditions for the osseointegration of the implant, but at the same time it is, and behaves like, a smooth surface at a micrometric (cellular) level. This means that while bone grows well on this surface, the adhesion of bacteria to the same surface is significantly reduced.

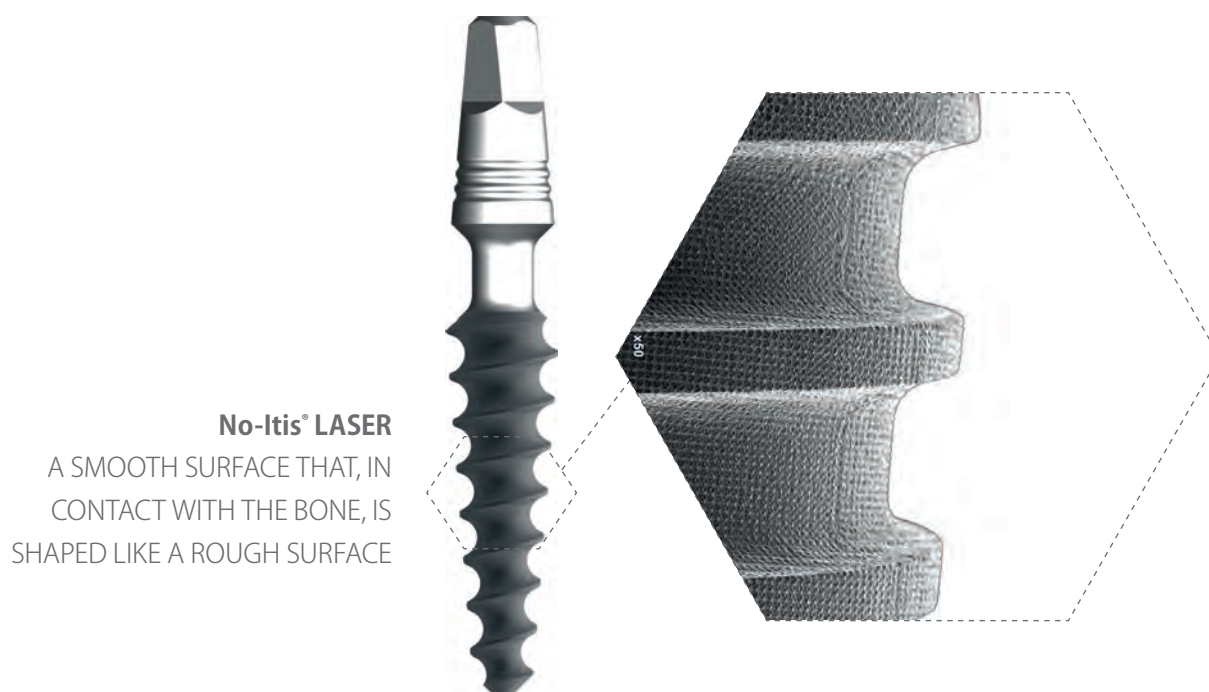

In the 1990s, rough surfaces on dental implants became increasingly popular – while the risk of bacterial adhesion was blissfully disregarded. This caused the appearance of a new disease, periimplantitis, which severely compromises the survival of the implants in the long term and which, as a result, requires a renewed intervention on a dissatisfied patient, wasting time and increasing costs. Surfaces like that are not patient-friendly!

The use of the laser technology we developed allows us to create an exactly defined micromorphology on the treated surface, leaving no residue and without altering the properties or composition of the titanium alloy. This creates a mesh of very perfect cavities in terms of the (hemispherical) shape and its dimensions (of 20 to 30 μm), as well as their distance and distribution. The surface of these cavities as well as the retentions created by laser ablation are smooth as experienced by the bacteria, a characteristic that is assumed to improve the resistance of the implant against bacterial colonisation. This characteristic might also radically limit the incidence of periimplantitis. In contact with the bone, however, the laser-ablated surface behaves like a rough surface. Rough implants (e.g., KOS®, Hexacone®) and smooth implants (e.g., BCS®, KOS®) therefore have the same recovery rate.

No-Itis® LASER
THE SURFACE THAT INCREASES SURVIVAL RATIOS

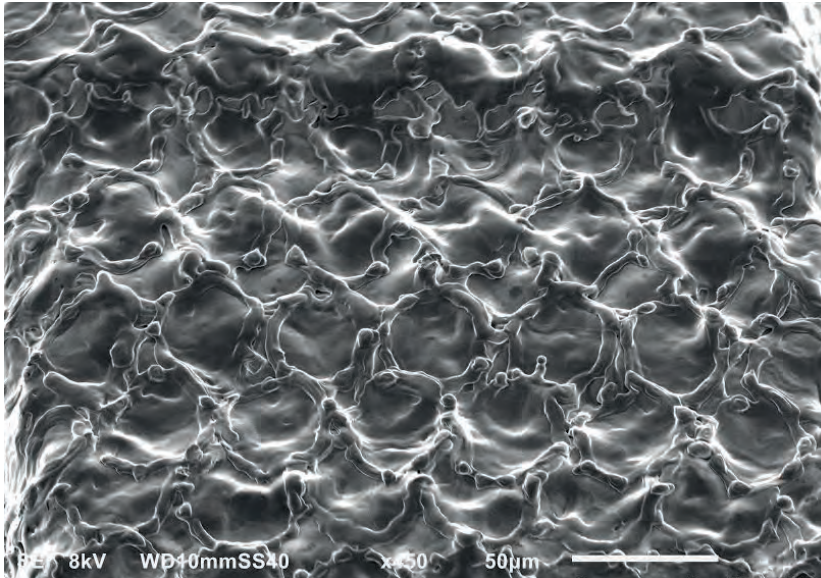

Rugosity (Ra)	Definition
---------------	------------

$\leq 0,4 \mu\text{m}$	Smooth
0,5 - 1,0 μm	Machined
1,0 - 2,0 μm	Moderately rough
$> 2,0 \mu\text{m}$	Rough

Rugosity (Ra)	No-Itis® Laser
---------------	----------------

0,9 μm	Smooth
-------------------	--------

According to the classification of surface roughness by Albrektsson and Wenneberg, the Ra value corresponds to a moderately rough surface, and our lasered surface actually has the characteristics and many of the advantages of a smooth implant surface. The NO-ITIS® LASER surface allows the adhesion of the uniform and extended fibrin clot, which then leads to the formation of woven bone. The distribution and size of the concavities favours the accommodation and activity of the osteoblasts, promoting effective osseointegration

No-Itis® LASER

THE MOST ADVANCED SURFACE A SAFE ANSWER AGAINST PERIIMPLANTITIS, MAINTAINING THE OSSEOINTEGRATION LONG TERM

STABLE FIBRIN MESH

With the NO-ITIS® LASER, as with traditional rough surface, fibrin filaments are almost exclusively attached to surface peaks forming bridges between them (distance osteogenesis). On the NO-ITIS® LASER surface, fibrin forms as a well developed and defined grid mesh even within the concavities, which favours colonisation of the osteogenic cells directly on the surface of the implant (contact osteogenesis).



Machined surface



Osteogenesis of contact

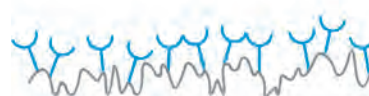

Rough surface



Distant osteogenesis



No-Itis® Laser Surface



Improved contact osteogenesis

MAXIMUM CONTACT OSTEOGENESIS

Thanks to the good cell adhesion, a normal fibrin mesh can be created, adapted and extended on the surface of the NO-ITIS® LASER. This process activates the formation of osteonal bone, also directly in contact with the implant.

No-Itis® LASER
A UNIQUE SURFACE

No-Itis® LASER

THE IDEAL SURFACE FOR IMMEDIATE
OR EARLY LOADING

The perfectly symmetrical and reproducible topography of the NO-ITIS® LASER surface attracts a greater number of osteogenic cells, allowing them to settle and to proliferate on the implant surface in a stable and uniform manner. This process activates the formation of bone directly in contact with the implant, resulting in a more dynamic and favourable osseointegration, with greater BIC (Bone implant Contact), and it allows true bone engineering.

- Smooth implant surface
- Less bacterial adhesion

➔ LOWER RISK OF INFECTIONS

- Increased fibrin adhesion
- More contact osteogenesis on a larger surface

➔ PERFECT OSSEOINTEGRATION

No-Itis® LASER – A CLEAN SURFACE

Unlike standard-surface implants (sandblasting and etching, or blasting and anodising), the implants with the NO-ITIS® LASER surface have a completely clean surface without residues nor contaminants. Due to this modern manufacturing process, no residues of jet particles or traces of the chemicals (acids) or anodisation (oxides) used in the etching process can come into contact with the implant. Eliminating the anodisation also eliminates the risk that the top layer of the coloured implant dissolves mechanically.

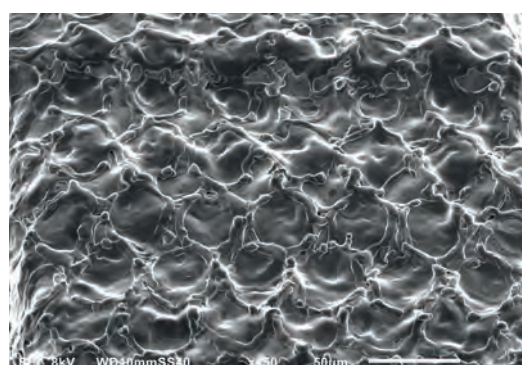

No-Itis® LASER

A CLEAN SURFACE

No-Itis® LASER – THE IDEAL SURFACE FOR BONE CONTACT

The total cleanliness of the NO-ITIS® LASER allows the endosseous implant surface to be increased without having to accept the disadvantages of all the traditional methods for surface roughening.

This new surface generation can coexist for some time with others developed by Ihde Dental AG, while regularization of production and stocks, and therefore any reference may not be available on the new No-Itis® Laser surface.

KOS® - INSTRUCTION FOR APPLICATION

PREPARATORY WORK

Get your lab to make a drilling template with the specified drill holes for the marking hole.

For the pilot hole, use **DOS 1** or **BCD 1** (yellow) as the primary reamer. Prepare the implant bed with the form drills at full length.

Please use an intermittent drilling technique with good NaCl cooling. If necessary, the laboratory can insert guide sleeves in the drill holes (code **BFH**) through which the precise direction of drilling can be set.

If, due to high drilling resistance in hard bone, it is difficult to reach the complete drilling depth with **DOS 1**, the correct depth can be reached with the cylinder drill **DS 2** (diameter 2 mm).

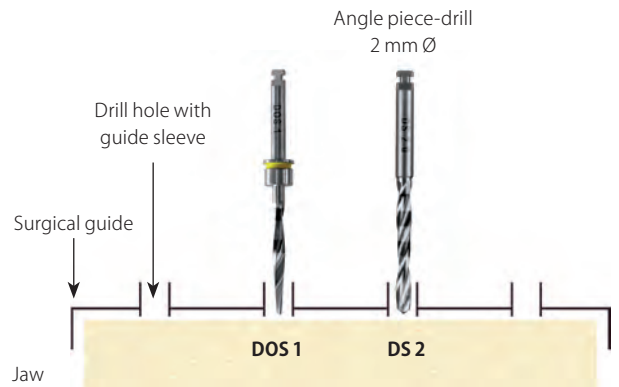

SURGERY

1. Drilling and preparation/compaction of the implant site

DRILL SEQUENCE normal / hard bone				DRILL SEQUENCE soft bone			
Pilot drill	Form drill	KDS	Implant	Pilot drill	Form drill	KDS	Implant
	---	KDS 3.0	KOS 3.0		---	---	KOS 3.0
	DOS 2	KDS 3.2	KOS 3.2		---	KDS 3.0	KOS 3.2
DOS 1	DOS 3 (4)	KDS 3.7	KOS 3.7	DOS 1	DOS 2	KDS 3.2	KOS 3.7
		KDS 4.1	KOS 4.1			KDS 3.7	KOS 4.1
	DOS 5	KDS 5.0	KOS 5.0		DOS 3 (4)	KDS 4.1	KOS 5.0

In very hard bone the implants should be inserted slightly deeper and then turned back 1/2 round.

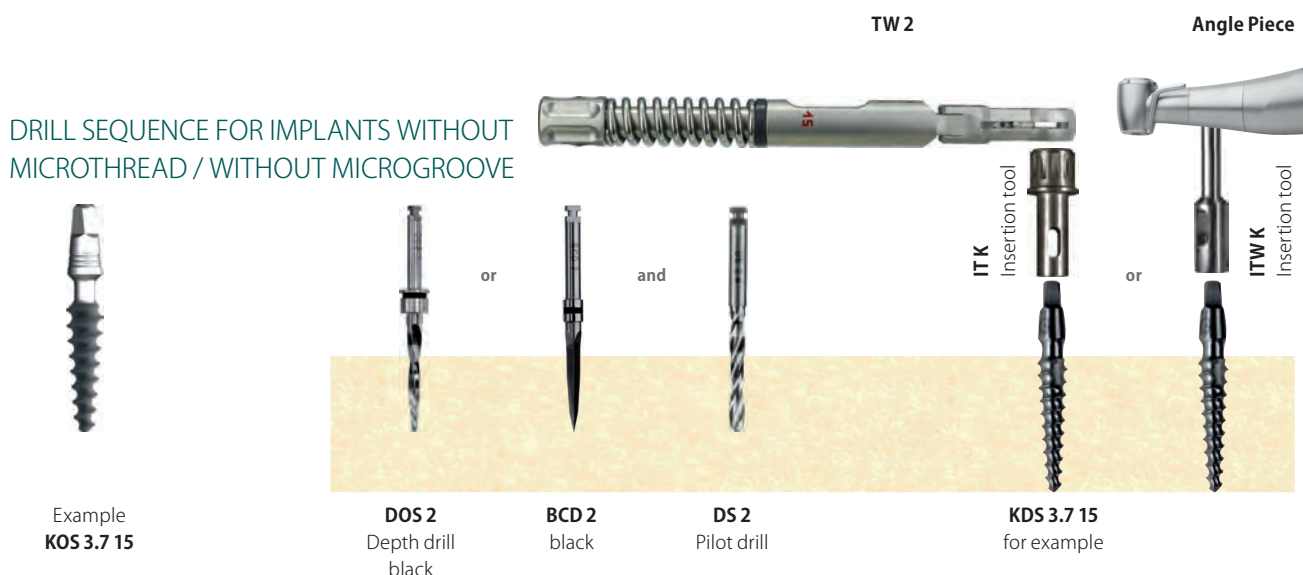

IMPLANTS WITH LARGE HEAD, MICROTHREAD AND MICROGROOVE

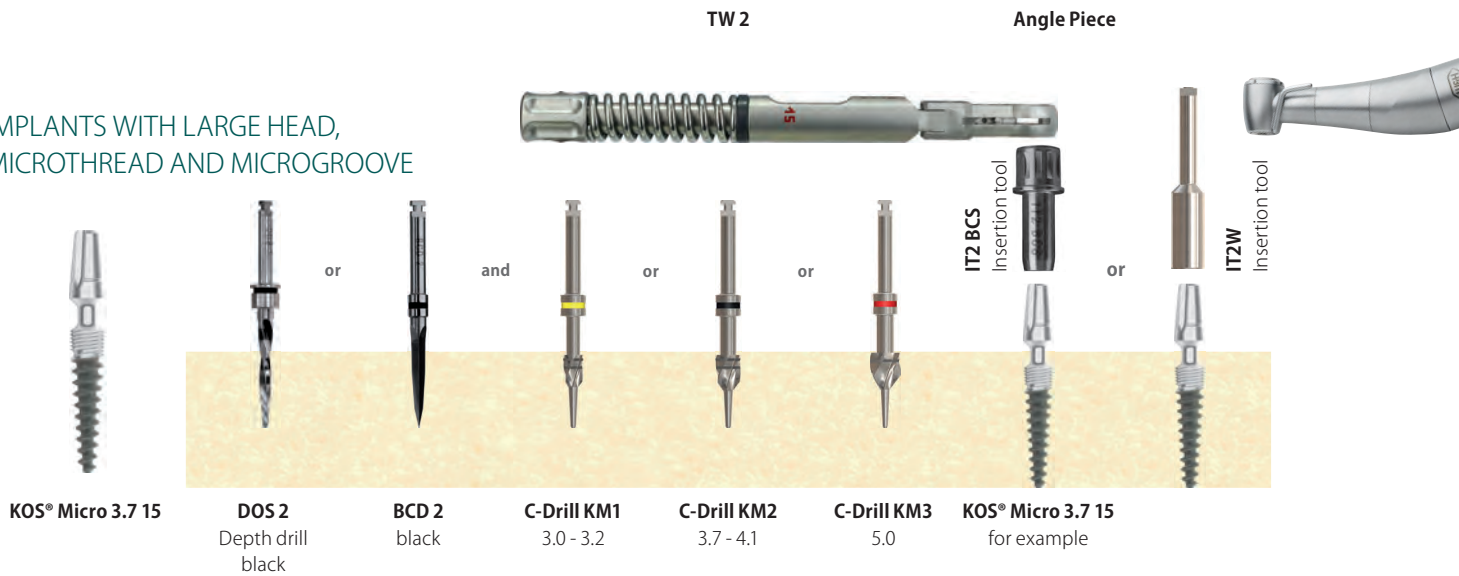

IMPLANTS WITH SMALL HEAD AND MICROTHREAD

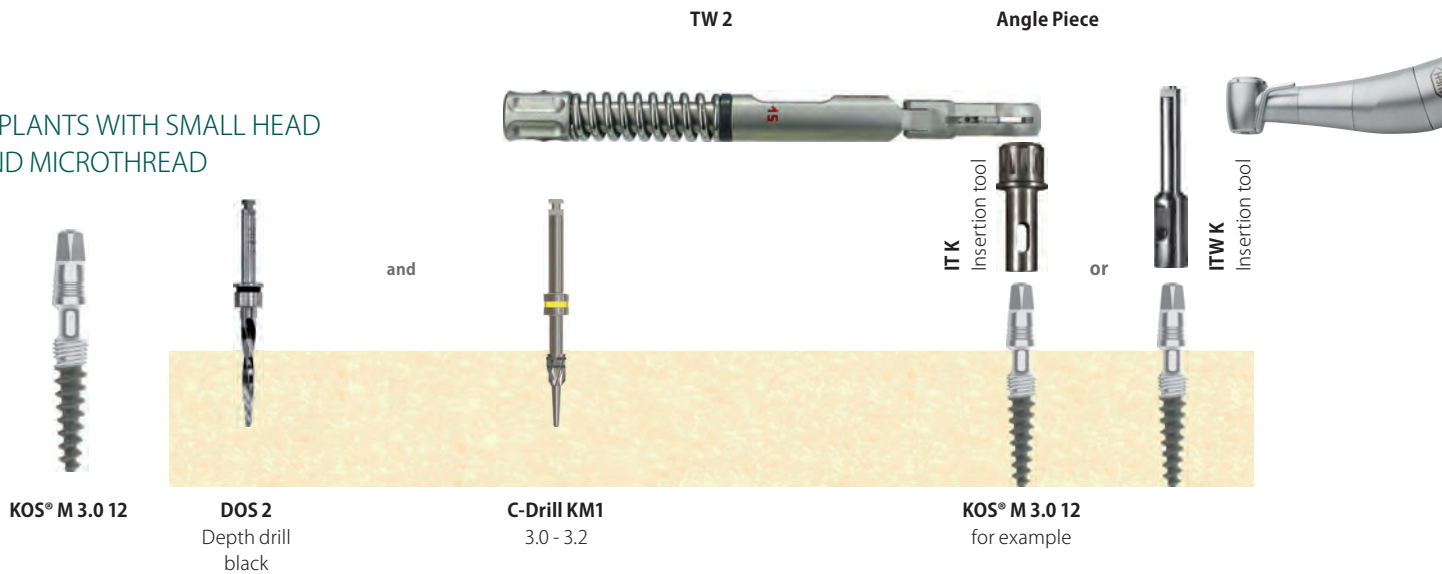

DOS 2/BCD 2 Direction and depth calculation; alternatively BCD 1 „Pathfinder“ drill.

Pilot drill DS 2 For use in hard bone in the cortical region only.

KDS Prepare the implant bed in the maxilla stepwise using the appropriate bone-expanding screw and ratchet or motorized insertion tool. Maximum 40-45 Ncm. Remove the bone-expanding screw again.

KOS® B To create the definitive implant cavity for **KOS® B** implants, it is imperative to use bone-expanding screws. These screws must be screwed to their full depth. They generate the compression and ensure that sufficient space is created for the implant thread in the cortical region.

All **KOS®** implants are used as compression screws. If possible, the hole should be created substantially thinner than the core diameter of the implant, since only in this way can good bone condensation be achieved. The minimum hole diameter depends on the bone density. For this reason, it is not possible to specify drill sequences that can be used favorably for all bone qualities. As a rule, it is necessary to drill much less into the soft maxilla (e.g. the DOS1 drill only can be used for **KOS®** implants with diameter 3.0-5.0) than into the well-mineralized mandible, which requires the use of a drilling sequence adjusted to the bone density.

2. Implant packaging



Original packaging



Open the sealed cover at the lid. Remove the label and place it into the patients record.

3. Remove the implant from its packaging



The open pack contains the implant, mounted to a plastic holder. The pack also contains the lab-set.

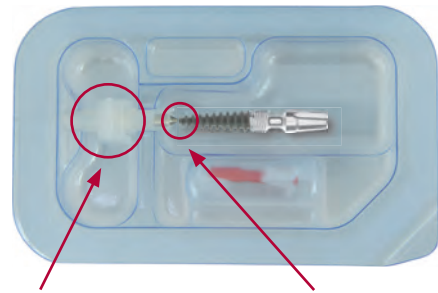

Remove the implant by holding onto the plastic holder

The implant is fixed to the holder by a break joint.

4. Handling

Hold the implant by the holder and place the insertion tool on the implant head. The endosseous implant surface must not be touched. Pull out the implant with the plug and then twist off the plug with the needle holder at the predetermined breaking point.

IMPLANTS WITH LARGE HEAD

KOS® / KOS® Micro

KOS® K (for ball attachment)



Predetermined break line

KOS® implant with insertion tool **IT2W** (for angle piece) and **IT2 BS** (manual)



KOS® K implant with insertion tool **IT TB K**



Twisting off the bracket with the needle holder

IMPLANTS
WITH SMALL HEAD

KOS® (straight) / KOS® B (flexible)



KOS® / KOS® B implants with
insertion tool **ITW K**
(for angle piece) and **IT K** (manual)

Twisting off the bracket with the
needle holder

5. Insertion using manual tools

Insert the implant by hand until it is firmly seated in the jaw.

IMPLANTS
WITH LARGE HEAD



IMPLANTS
WITH SMALL HEAD

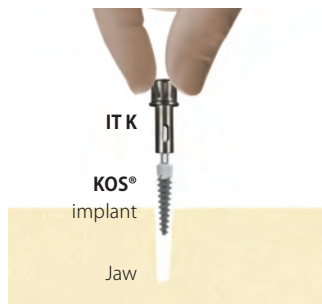

6. Definitive implant insertion

Using the ratchet, torque ratchet or contra-angle, screw the implant clockwise into the cavity. With **KOS® B**, the use of the torque ratchet is mandatory. The endosseous (blasted) part of the implant must be completely covered by bone. The polished implant neck is located in the mucosa. We recommend screwing the implant into the bone up to 1 mm deeper into the implant neck.

IMPLANTS WITH LARGE HEAD



The head of the bendable **KOS® 3.0 & 3.2, KOS® Micro (all diameters)** and **KOS® B** screws can be bent into the desired position after insertion with the aid of the mounted insertion tool and ratchet.

Maximum bend: approx. 15°. Only one bending operation may be performed. In the maxilla, the motorised insertion tool should be used due to its better implant guidance during insertion.



IMPLANTS WITH SMALL HEAD



IMPORTANT NOTE

KOS® implants have a predetermined breaking point integrated into the head. If the preparation with bone-expanding screws was not performed sufficiently, high screwing forces can cause the upper head portion to be torn off.

So that the implant can be screwed out again, an additional square is milled below the breaking point, into which the emergency tool **Tool E** can be inserted. The **Tool E** instrument may only be used to remove the implant.

7. Removing the placement aid from the implant

IMPLANTS WITH LARGE HEAD

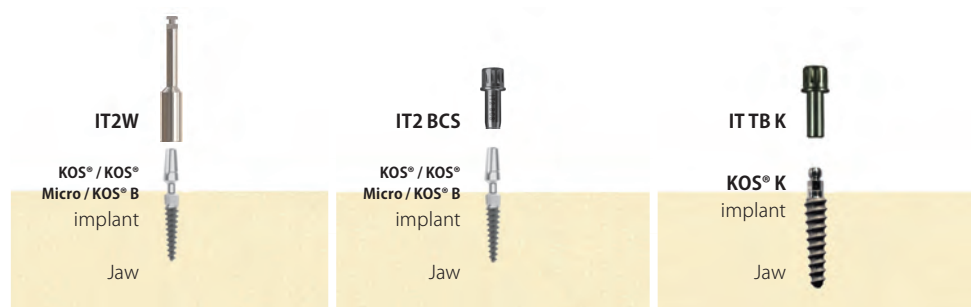

IMPLANTS WITH SMALL HEAD

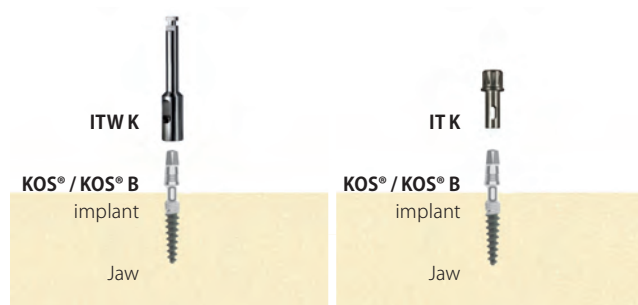

8. Result

All implant heads (except for the **KOS® K**) can be reshaped by grinding. The implants can be prosthetically supplied immediately if indicated. The definitive superstructure should be cemented within a few days. Immediate prosthetic splinting with a provisional bridge is recommended.

IMPLANTS WITH LARGE HEAD

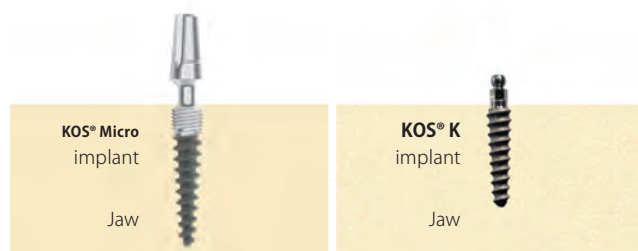

IMPLANTS WITH SMALL HEAD

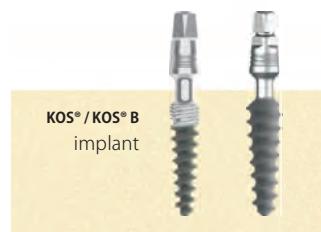

9. Impression

IMPLANTS WITH LARGE HEAD

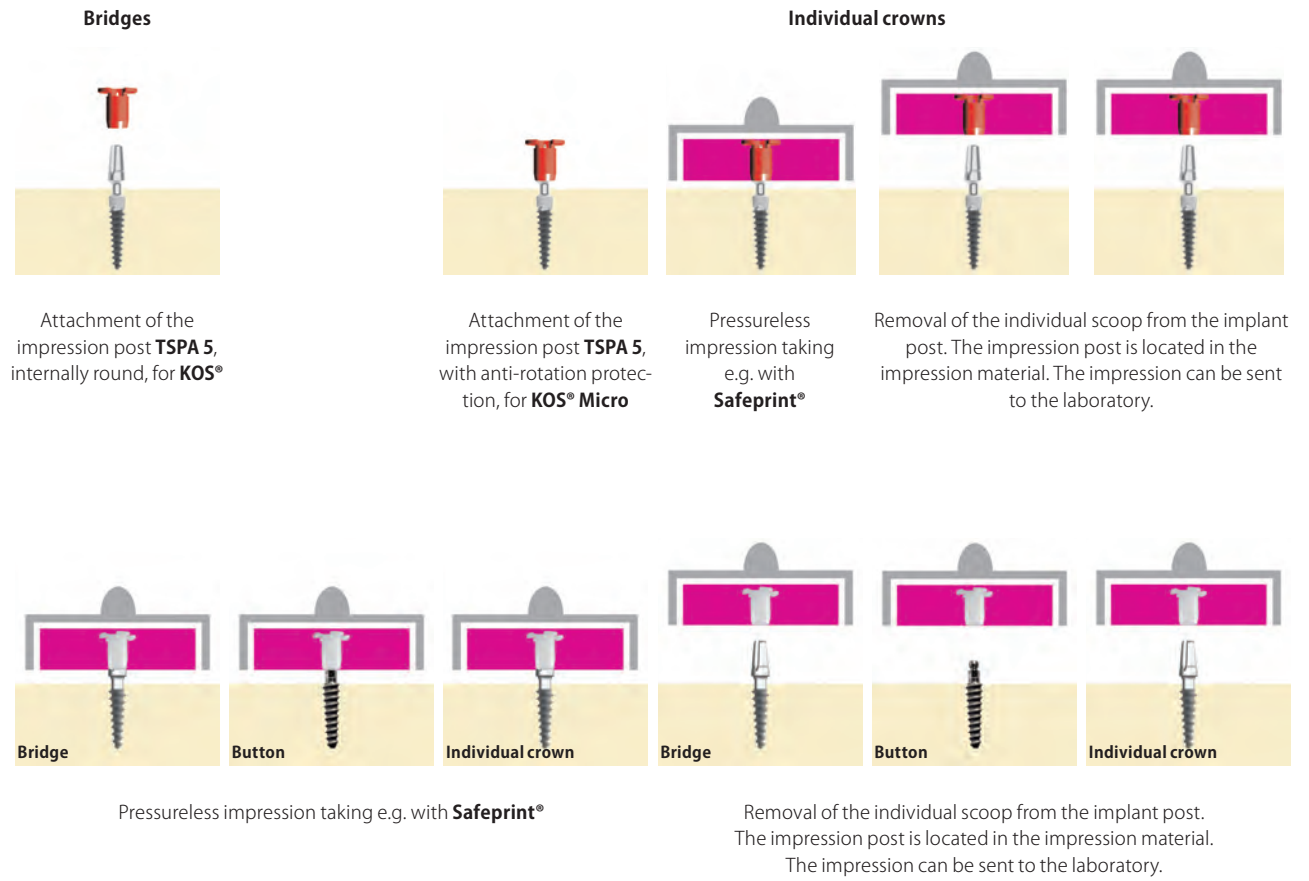

IMPLANTS WITH SMALL HEAD

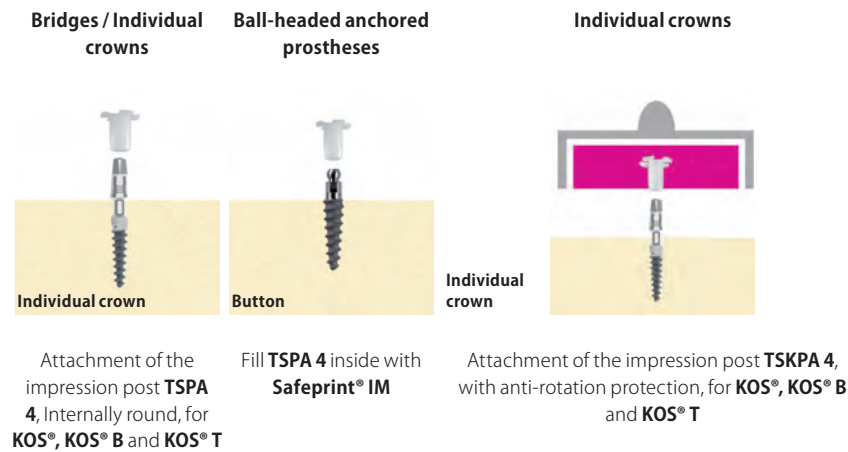

LABORATORY PROCEDURES

Attachment of the impression post onto lab analogues

IMPLANTS WITH LARGE HEAD

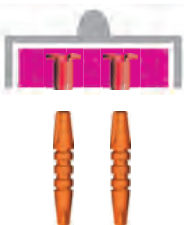

Bridges

TSPA 5 on IA4/IAU



Dentures

TSPA 5 on IA4/IAU



Individual crowns

TSPA 5 on IA4/IAU

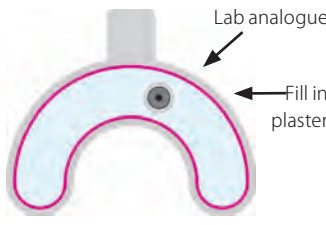

Create plaster model

Lab analogue
Fill in plaster

Pull impression from the model. The impression post and analogue are now separated again.



POB

IA4/IAU



PO4A or PO4

IA4/IAU

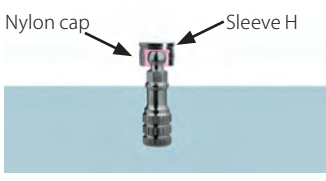

Nylon cap
Sleeve H

IA4/IAU with nylon cap (pink) and sleeve

Polymerization of the sleeve H into the prosthesis.
Press **NC/NC1/NC2** into the sleeve.
For initial restorations, **NC1** or **NC2** should be used.

The modeling is performed on the castable parts **PO4/POB** (internally round; for bridges and bars) or **PO4A** (edged inside; for individual crowns).

IMPLANTS WITH SMALL HEAD



Bridges

TSPA 4 on IA4/IAU



Dentures

TSPA 4 on IA4/IAU



Individual crowns

TSKPA 4 on IA4/IAU

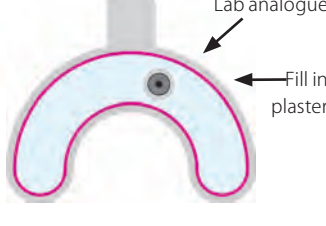

Create plaster model

Lab analogue
Fill in plaster

Pull impression from the model. The impression post and analogue are now separated again.



PO4

IA4/IAU



PO4 A

IA4/IAU



Nylon cap
Sleeve H

IA4/IAU with nylon cap (pink) and Sleeve

Polymerization of the sleeve H into the prosthesis.
Press **NC/NC1/NC2** into the sleeve.
For initial restorations, **NC1** or **NC2** should be used.

The modeling is performed on the castable parts **PO4** (internally round; for bridges and bars) or **PO4A** (edged inside; for individual crowns).



THE ADVANTAGES OF KOS® CLASSIC AND CLASSIC X IMPLANTS

SMALL HEAD



LARGE HEAD



Immediate loading protocol

Very few working steps

No micro gap

Compression thread

Made of highly resistant titanium alloy

KOS® CLASSIC IMPLANTS

Implants with small head for crowns and bridges.

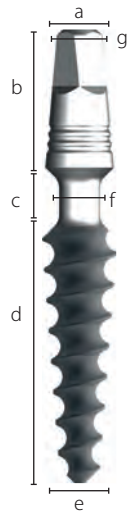

		Description	Enossal Ø	Enossal length	Neck Ø	REF	Price cat.
		KOS 3.0 10	3.0 mm	10 mm	2.0 mm	455108	F
		KOS 3.0 12	3.0 mm	12 mm	2.0 mm	455109	F
		KOS 3.0 15	3.0 mm	15 mm	2.0 mm	455110	F
		KOS 3.2 12	3.2 mm	12 mm	2.0 mm	455111	F
		KOS 3.2 15	3.2 mm	15 mm	2.0 mm	455112	F
		KOS 3.7 6	3.7 mm	6 mm	2.5 mm	455106	F
		KOS 3.7 8	3.7 mm	8 mm	2.5 mm	455107	F
		KOS 3.7 10	3.7 mm	10 mm	2.5 mm	455114	F
		KOS 3.7 12	3.7 mm	12 mm	2.5 mm	455115	F
		KOS 3.7 15	3.7 mm	15 mm	2.5 mm	455120	F
		KOS 4.1 8	4.1 mm	8 mm	2.8 mm	455129	F
		KOS 4.1 10	4.1 mm	10 mm	2.8 mm	455130	F
		KOS 4.1 12	4.1 mm	12 mm	2.8 mm	455132	F
		KOS 4.1 15	4.1 mm	15 mm	2.8 mm	455135	F
		KOS 4.1 17	4.1 mm	17 mm	2.8 mm	455136	F
		KOS 4.1 19	4.1 mm	19 mm	2.8 mm	455137	F
a) Abutment Ø	3.35 mm						
b) Abutment height	6.8 mm						
c) Neck length	3.5 mm						
d) Enossal length	6 - 19 mm						
e) Enossal Ø	3.0 - 5.0 mm						
f) Neck Ø	2.0 / 2.5 / 2.8 mm						
g) Square AF (across flats)	1.9 mm						

KOS 3.0 - 3.2 Max. insertion torque 50 Ncm

KOS 3.7 - 5.0 Max. insertion torque 80 Ncm



INCLUSIVE

KOS® implants are delivered incl. lab-set REF 462353, consisting of



Double analogue, plastic

IA4/IAU

462111



Impression post castable, internally edged, for large head

PA X

462136



Impression post castable, internally round, for small head

TSPA 4

462029

NOTE This is a standard lab-set and therefore contains parts for both **LARGE** abutment heads (**PA X**) and **SMALL** abutment heads (**TSPA 4**).

KOS® CLASSIC X IMPLANTS

Large head for easy prosthetic handling.

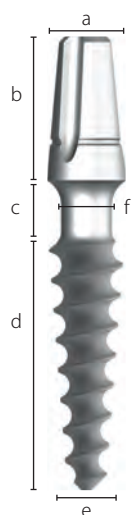

a) Abutment Ø	3.9 mm
b) Abutment height	7.2 mm
c) Neck length	3.0 mm
d) Enossal length	8 - 19 mm
e) Enossal Ø	3.0 - 5.0 mm
f) Neck Ø	2.0, 2.5, 2.8 mm

Description	Enossal Ø	Enossal length	Neck Ø	REF	Price cat.
KOS X 3.0 10	3.0 mm	10 mm	2.0 mm	455700	F
KOS X 3.0 12	3.0 mm	12 mm	2.0 mm	455701	F
KOS X 3.0 15	3.0 mm	15 mm	2.0 mm	455702	F
KOS X 3.2 12	3.2 mm	12 mm	2.0 mm	455710	F
KOS X 3.2 15	3.2 mm	15 mm	2.0 mm	455711	F
KOS X 3.7 10	3.7 mm	10 mm	2.5 mm	455720	F
KOS X 3.7 12	3.7 mm	12 mm	2.5 mm	455721	F
KOS X 3.7 15	3.7 mm	15 mm	2.5 mm	455722	F
KOS X 4.1 8	4.1 mm	8 mm	2.8 mm	455730	F
KOS X 4.1 10	4.1 mm	10 mm	2.8 mm	455731	F
KOS X 4.1 12	4.1 mm	12 mm	2.8 mm	455732	F
KOS X 4.1 15	4.1 mm	15 mm	2.8 mm	455733	F
KOS X 4.1 17	4.1 mm	17 mm	2.8 mm	455734	F
KOS X 4.1 19	4.1 mm	19 mm	2.8 mm	455735	F
KOS X 5.0 10	5.0 mm	10 mm	2.8 mm	455740	F
KOS X 5.0 12	5.0 mm	12 mm	2.8 mm	455741	F
KOS X 5.0 15	5.0 mm	15 mm	2.8 mm	455742	F



INCLUSIVE

KOS® implants are delivered incl. lab-set REF 462353, consisting of



Double analogue, plastic

IA4/IAU

462111



Impression post castable, internally edged, for large head

PAX

462136



Impression post castable, internally round, for small head

TSPA 4

462029

ACCESSORIES

Analogue IAB

Pack of 5

REF 462106

Price cat. B



Impression post TSPA 5

Pack of 5

REF 462030

Price cat. B

The red impression cap and the red analogue are round (not secured against rotation).

NOTE This is a standard lab-set and therefore contains parts for both **LARGE** abutment heads (**PA X**) and **SMALL** abutment heads (**TSPA 4**).

THE ADVANTAGES OF KOS® B IMPLANTS

Suitable for bridges in the reduced-load range

The bendable implant offers dual safety:

1. Torque reduction by pre-compression with the congruent bone-expanding screw

2. Safety head with predetermined breaking point and dual square

KOS® B IMPLANTS WITH SMALL HEAD FOR BRIDGES

KOS® B implants with bendable neck (use after pre-drilling and preparation with the bone-expanding screw). Suitable for bridges in the reduced-load range (no individual tooth restorations). The bendable implant now offers dual safety:

1. Torque reduction by pre-compression with the congruent bone-expanding screw
2. Safety head with predetermined breaking point and dual square



Description	Code KDS	Enossal Ø	Enossal length	REF	Price cat.
KOS B 3.0 15	C	3.0 mm	15 mm	455160	F
KOS B 3.2 12	D	3.2 mm	12 mm	455162	F
KOS B 3.2 15	E	3.2 mm	15 mm	455161	F
KOS B 3.7 12	F	3.7 mm	12 mm	455164	F
KOS B 3.7 15	G	3.7 mm	15 mm	455165	F
KOS B 4.1 15	L	4.1 mm	15 mm	455166	F
KOS B 4.1 17	M	4.1 mm	17 mm	455167	F

The predetermined fracture site integrated in the abutment prevents the twisting off of the abutment head from the endosseous implant part. The implant socket has to however always be pre-compressed using the bone-expanding screw.

- a) Abutment Ø 3.35 mm
- b) Abutment height 6.8 mm
- c) Neck length 3.0 mm
- d) Enossal length 12 - 17 mm
- e) Enossal Ø 3.0 - 4.1 mm
- f) Neck Ø 1.8 mm

Max. insertion torque 45 Ncm



INCLUSIVE

KOS® implants are delivered incl. lab-set REF 462353, consisting of



Double analogue, plastic

IA4/IAU

462111



Impression post castable, internally edged, for large head

PA X

462136



Impression post castable, internally round, for small head

TSPA 4







462029



After insertion, the bendable KOS® B screws can be bent into the desired position using the inserted insertion aid and ratchet. Maximum bend: approx. 15°. Only one bending process may take place. The motor insertion aid should be used in the upper jaw because of the better implant guidance when screwing in.

NOTE This is a standard lab-set and therefore contains parts for both **LARGE** abutment heads (**PA X**) and **SMALL** abutment heads (**TSPA 4**).

IMPRESSION TAKING AND LABORATORY ACCESSORIES



	Description	Unit	Code	REF	Price cat.
	Impression post made of POM Castable, internally round	Pack of 5	TSPA 4*	462029	B
	ALTERNATIVE Impression post made of POM Castable, internally round	Pack of 5	TSPA 4*	462027	B
	Impression post Castable, internally edged	Pack of 5	TSKPA 4	462028	B
	Double analogue, plastic For large and small head	Pack of 5	IA4/IAU	462111	B
	Double analogue, metal For large and small head	1 piece	IA4/IAU	462112	A
	Castable abutment and base for provisionals For small head 7 mm high, white, internally round	Pack of 5	PO4	462088	B
	Castable abutment and base for provisionals For small head 7 mm high, white, internally edged	Pack of 5	PO4A	462089	B

***TSPA 4 and 5** For impressions on ground-down implant heads.

This ring-transfer exposes the lower border of the abutment head. The impression is then poured with extra-strong gypsum or epoxy-resin. For this techniques no implant analogues are needed. Material: PP

SCANNER ANALOG

Scanner analogue for large and small implant head, self-descriptive. These analogues do not need to be sprayed with spray paint. They can be pulled out of the model with anti-rotation protection. Matching impression posts: **TSPA 4** and **TSPA 5**

	Description	REF	Price cat.
IAS 4 	Scanner analogue IAS 4 For small head	462019	B
IAS 5 	Scanner analogue IAS 5 For large head	462020	B

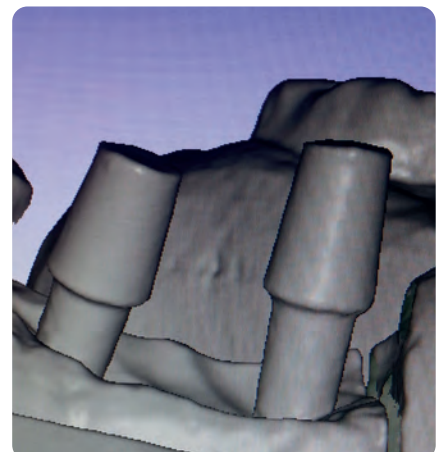



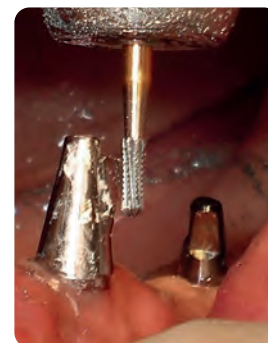

Use example for self-descriptive scanner analogue

CEMENTABLE ANGULATION ADAPTER (Ti6AL4V)

These adapters are mounted on **KOS®** implants to compensate for the insertion direction. Plastic cements are preferably used. The implant head must be roughened beforehand. The protruding head parts are then removed. The impression is taken directly on the adapter.



	Description	Code	REF	Price cat.
	Adapter, 15° For small head	AA15 KK	462036	C
	Adapter, 25° For small head	AA25 KK	462046	C
	Adapter, 15° For large head	AA5 15°	462052	C
	Adapter, 25° For large head	AA5 25°	462053	C

CASTABLE CROWN BASE

These adapters are used by the dental technician for modeling of bridge frames. In the metal try-in, the protruding head parts are removed by the dentist.

	Description	Height	Code	REF	Price cat.
	Adapter 15° For small head Reducible and castable Pack of 5	7.5 mm	AAL 15 KK	462045	C

LAB ANALOGUE

	Description	Code	REF	Price cat.
	Abutment analogue for angulation adapter For small head 15° and 25°	AAA	462049	B

CASTABLE PART AND IMPRESSION CAP

	Description	Code	REF	Price cat.
	Castable abutment and transfer for AAA Pack of 5	PA AAA	462050	B

KDS BONE EXPANDING SCREWS

For all **KOS® B** screw implants, bone-expanding screws are available as tools to create the definitive implant cavity. Basically, for each implant prior to insertion of a **KOS® B** screw implant, a bone compression with the bone-expanding screw should be performed. In addition, with a narrow alveolar ridge, an expansion of the alveolar ridge can be performed with the bone-expanding screw. By inserting the bone-expanding screw, it can be checked whether the **KOS® B** screw implant can be inserted into the bone easily and fully. Titanium alloy Ti6Al4V, machined. Tighten with **IT K**, **ITS K** or **ITX K** using the torque ratchet **TW2** (max. 45 Ncm), or alternatively **RAT 2**. Package unit: 1 piece, non-sterile

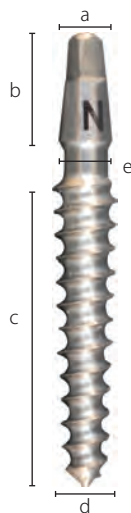

Description	Code KDS	Enossal Ø	Enossal length	Neck Ø	REF	Price cat.
KDS 3.0 10	A	3.0 mm	10 mm	2.0 mm	455212	F
KDS 3.0 12	B	3.0 mm	12 mm	2.0 mm	455213	F
KDS 3.0 15	C	3.0 mm	15 mm	2.0 mm	455214	F
KDS 3.2 12	D	3.2 mm	12 mm	2.5 mm	455223	F
KDS 3.2 15	E	3.2 mm	15 mm	2.5 mm	455224	F
KDS 3.7 12	F	3.7 mm	12 mm	2.8 mm	455233	F
KDS 3.7 15	G	3.7 mm	15 mm	2.8 mm	455234	F
KDS 4.1 8	H	4.1 mm	8 mm	2.8 mm	455241	F
KDS 4.1 10	I	4.1 mm	10 mm	2.8 mm	455242	F
KDS 4.1 12	K	4.1 mm	12 mm	2.8 mm	455243	F
KDS 4.1 15	L	4.1 mm	15 mm	2.8 mm	455244	F
KDS 4.1 17	M	4.1 mm	17 mm	2.8 mm	455245	F
KDS 4.1 19	N	4.1 mm	19 mm	2.8 mm	455246	F

- a) Abutment Ø 3.35 mm
- b) Abutment height 6.8 mm
- c) Enossal length 8 - 19 mm
- d) Enossal Ø 3.0 - 4.1 mm
- e) Neck Ø 2.0 - 2.8 mm

The bone-expanding screws can easily be screwed in using suitable insertion tools and immediately screwed out again after reaching the full insertion depth. Subsequently, the **KOS® B** implant is inserted. With the **KOS® B** (bendable), **the use of bone-expanding screws is mandatory regardless of the region**, so that the shear forces occurring during insertion do not fracture the implant neck.

Do not use for KOS® implants with microthread.

THE ADVANTAGES OF KOS® PLUS IMPLANTS

Vertical grooves for anti-rotation protection

No micro gap

Polished apical cutting thread for anchorage in the opposite cortical

Combines the advantages of the compression screw with the advantages of the bicortical screw

In addition to bone compression, there is also anchorage in the 2nd (opposite) cortical

Enossal part with special No-Itis® laser surface

Optimal primary stability thanks to the micro thread and aggressive apical thread

Can be used in the maxilla and mandible

Made of highly resistant titanium alloy

KOS® PLUS IMPLANTS

KOS® PLUS are made in one piece and have a polished apical cutting thread for anchorage in the opposite cortical. KOS® Plus combines the advantages of the compression screw with the advantages of the bicortical screw: in addition to bone compression, there is also anchorage in the 2nd cortical (opposite cortical). Can be used in the maxilla and mandible. Made of titanium alloy Ti6Al4V, laserd. Tighten with **IT2 BCS**.



Description	Neck Ø	Compression thread	Enossal length	REF	Price cat.
KOS 3.7 9+3	2.5 mm	9 mm	12 mm	455800	G
KOS 3.7 11+3	2.5 mm	11 mm	14 mm	455801	G
KOS 3.7 13+3	2.5 mm	13 mm	16 mm	455802	G
KOS 3.7 16+3	2.5 mm	16 mm	19 mm	455803	G
KOS 3.7 20+3	2.5 mm	20 mm	23 mm	455804	G
KOS 4.1 6+3	2.8 mm	6 mm	9 mm	455810	G
KOS 4.1 9+3	2.8 mm	9 mm	12 mm	455811	G
KOS 4.1 11+3	2.8 mm	11 mm	14 mm	455812	G
KOS 4.1 13+3	2.8 mm	13 mm	16 mm	455813	G
KOS 4.1 20+3	2.8 mm	20 mm	23 mm	455814	G
KOS 5.0 6+3	2.8 mm	6 mm	9 mm	455820	G
KOS 5.0 9+3	2.8 mm	9 mm	12 mm	455821	G
KOS 5.0 11+3	2.8 mm	11 mm	14 mm	455822	G
KOS 5.0 13+3	2.8 mm	13 mm	16 mm	455823	G

a) Abutment Ø	3.9 mm
b) Abutment height	7.2 mm
c) Neck length	3.5 mm
d) Enossal length	9 - 23 mm
e) Apical thread Ø	4.5 mm
f) Area for 2 nd cortical engagement	3.0 mm
g) Enossal compression region	6 - 20 mm
h) Enossal Ø	3.7 / 4.1 / 5.0 mm
i) Neck Ø	2.5 / 2.8 mm



INCLUSIVE

KOS® implants are delivered incl. lab-set REF 462353, consisting of



Double analogue, plastic

IA4/IAU

462111



Impression post castable, internally edged, for large head

PA X

462136



Impression post castable, internally round, for small head

TSPA 4

462029

ACCESSORIES

Analogue **IAB**

Pack of 5

REF 462106

Price cat. B



Impression post **TSPA 5**

Pack of 5

REF 462030

Price cat. B

The red impression cap and the red analogue are round (not secured against rotation).

NOTE This is a standard lab-set and therefore contains parts for both **LARGE** abutment heads (**PA X**) and **SMALL** abutment heads (**TSPA 4**).

EXAMPLE OF USE OF KOS® PLUS IMPLANTS



Bicortical anchorage of a **KOS® Plus** implant in the atrophied distal mandible.

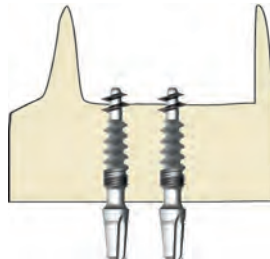

Bicortical anchorage of a **KOS® Plus** implant in the area of the nasal floor.

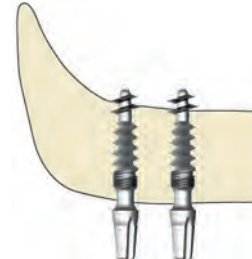

Bicortical anchorage of **KOS® Plus** implants (Ø 3.7 and 4.1) in the area of the maxillary sinus.

NOTE - KOS® Plus may only be operated/used by validly authorized users. Only polished implant parts may penetrate a maximum of 1.5 mm into the opposite cortical. For a given indication (min. three stable implants, sufficient bone quality, etc.), **KOS® Plus** are suitable for immediate loading.

AUXILIARY TOOL

Auxiliary tool for determining the plane of bite in relation to the Camper's plane and the bipupillary line during the creation of the upper jaw part of the bite registration. Can be used with wax or silicone.

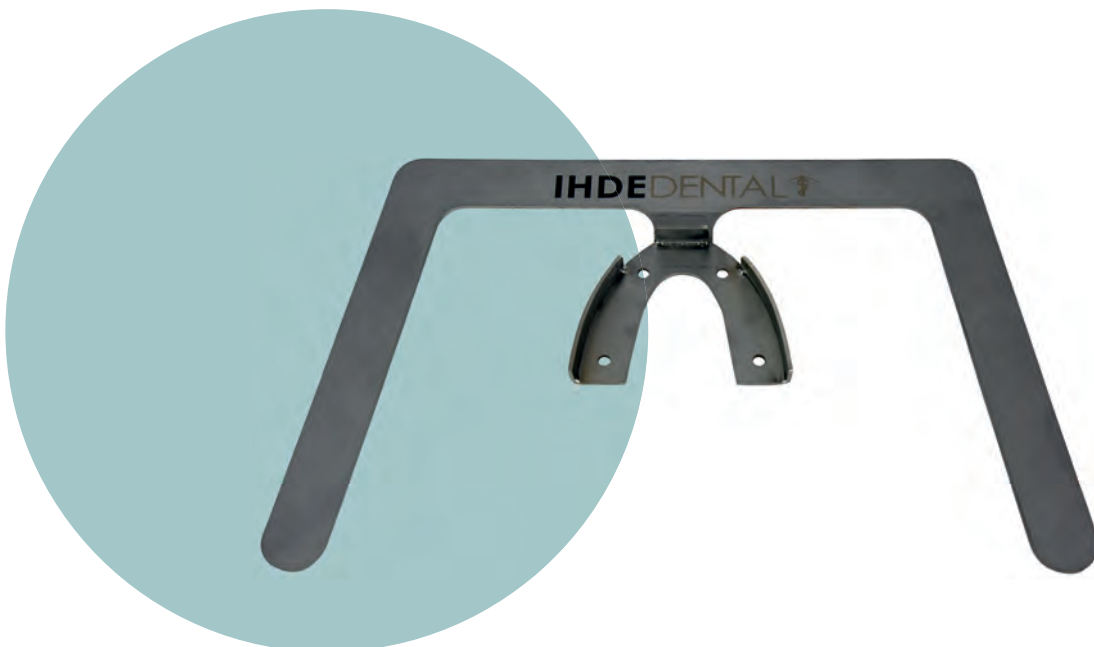

REF	Price cat.
462380	N

THE ADVANTAGES OF KOS® TX IMPLANTS

Compression screw implant with an extended polished and bendable neck

For anchorages in the tuberosity and in regions with large mucosal thickness

Is preferably used without flap preparation

The nominal \varnothing is reached at the widest part of the compression thread

KOS® TX IMPLANTS

KOS® TX is a compression screw implant with an extended polished and bendable neck (6 mm) for anchorages in the tuberosity and in regions with large mucosal thickness. The roughened thread parts must be completely submerged in the bone. **KOS® TX** is preferably used without flap preparation. The nominal diameter is reached at the widest part of the compression thread.

Cementing platform

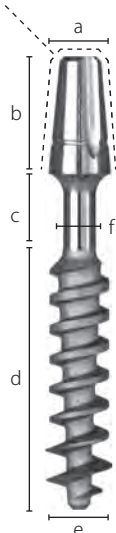
**Description**

KOS TX 3.0 12
KOS TX 3.0 15
KOS TX 3.0 18
KOS TX 3.7 12
KOS TX 3.7 15
KOS TX 3.7 18
KOS TX 4.0 12
KOS TX 4.0 15
KOS TX 4.0 18
KOS TX 4.0 21

Enossal Ø

3 mm
3 mm
3 mm
3.7 mm
3.7 mm
3.7 mm
4 mm
4 mm
4 mm
4 mm

Enossal length

12 mm
15 mm
18 mm
12 mm
15 mm
18 mm
12 mm
15 mm
18 mm
21 mm

REF

455001
455002
455003
455005
455006
455007
455175
455176
455177
455178

Price cat.

F
F
F
F
F
F
F
F
F
F

- a) Abutment Ø 3.9 mm
b) Abutment height 7.2 mm
c) Neck length 6 mm
d) Enossal length 12 - 21 mm
e) Max. enossal Ø 4 mm
f) Neck Ø 2 mm

Max. insertion torque 80 Ncm

**INCLUSIVE**

KOS® implants are delivered incl. lab-set REF 462353, consisting of



Double analogue, plastic

IA4/IAU

462111



Impression post castable, internally edged, for large head

PA X

462136



Impression post castable, internally round, for small head

TSPA 4

462029

ACCESSORIES

Analogue **IAB**

Pack of 5

REF 462106

Price cat. B



Impression post **TSPA 5**

Pack of 5









REF 462030

Price cat. B





The red impression cap and the red analogue are round (not secured against rotation).

NOTE This is a standard lab-set and therefore contains parts for both **LARGE** abutment heads (**PA X**) and **SMALL** abutment heads (**TSPA 4**).

INSERTION TOOLS

	Description	Code	REF	Price cat.
	 Insertion tool long, for large head Use with RAT 2 or TW2	IT2 BCS	900030	E
	 Insertion tool short, for large head Use with RAT 2 or TW2	IT2 S BCS	900038	E
	 Length 23 mm, for KOS and BCS implants	IT2W	900039	E
	 Adapter for implants with large head For handgrip 311431 (see page 50)	AHB	900037	F

IMPRESSION TAKING AND LABORATORY ACCESSORIES

	Description	Unit	Code	REF	Price cat.
	Impression post castable, POM Internally round	Pack of 5	TSPA 5*	462030	B
	Impression post castable, Internally edged	Pack of 5	PA X	462136	B
	Double analogue, plastic For large and small head	Pack of 5	IA4/IAU	462111	B
	Double analogue aus Metal For large and small head	1 piece	IA4/IAU	462112	A
	Castable abutment for large head Internally round	Pack of 5	POB	462086	B

***TSPA 4 and 5** For impressions on ground-down implant heads.

This ring-transfer exposes the lower border of the abutment head. The impression is then poured with extra-strong gypsum or epoxy-resin. For this techniques no implant analogues are needed. Material: PP

THE ADVANTAGES OF KOS® MU IMPLANTS

Feature a pre-angulation of 15°

May be bent additionally, using the insertion tool

In conjunction with the clinically possible rotational positions of the head, virtually all possible angulations can be realized

Made of highly resistant titanium alloy

KOS® MU IMPLANTS

KOS® MU implants feature a pre-angulation of 15 degrees. KOS® MU may be bent additionally, using the insertion tool. In conjunction with the clinically possible rotational positions of the head, virtually all possible angulations can be realized. Material **Ti6Al4V**.

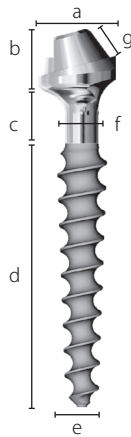

a) Abutment Ø	4.8 mm
b) Abutment height	3.7 mm
c) Trans-mucosal height	3 mm
d) Enossal length	8 - 15 mm
e) Enossal Ø	3.0 - 5.0 mm
f) Neck Ø	2 mm
g) Height of connecting part	2 mm
Prosthetic screw	SFK MU

Description	Enossal Ø	Enossal length	REF	Price cat.
KOS MU 3.0 15	3.0 mm	15 mm	455830	L
KOS MU 3.2 12	3.2 mm	12 mm	455838	L
KOS MU 3.2 15	3.2 mm	15 mm	455839	L
KOS MU 3.7 10	3.7 mm	10 mm	455840	L
KOS MU 3.7 12	3.7 mm	12 mm	455841	L
KOS MU 3.7 15	3.7 mm	15 mm	455831	L
KOS MU 4.1 8	4.1 mm	8 mm	455842	L
KOS MU 4.1 10	4.1 mm	10 mm	455843	L
KOS MU 4.1 12	4.1 mm	12 mm	455832	L
KOS MU 4.1 15	4.1 mm	15 mm	455833	L
KOS MU 5.0 10	5.0 mm	10 mm	455834	L
KOS MU 5.0 12	5.0 mm	12 mm	455835	L













MULTI-UNIT LAB SET



Description	Code	REF	Price cat.
Titanbasis Use with SF K MU	T-Base MU	418188	
Castable abutment Use with T-Base and SF K MU	PA2 MU	418189	
Prosthetic screw For KOS® MU and BCS® MU	SFK K MU	418164	
COMPLETE SET		418289	E

ACCESSORIES SINGLE-PIECE MULTI-UNIT IMPLANTS

	Description	Code	REF	Price cat.
   	Insertion tool for KOS® MU, BCS® MU and Hexacone® Plus MU 15° Use with IT2 BCS, IT2 S BCS, AH MU Tool HT 1.25	ITX MU15	418203	G
	Insertion tool long For large head Use with RAT2 and TW2, length 19 mm	IT2 BCS	900030	E
	Insertion tool short For large head Use with RAT2 and TW2, length 7 mm	IT2 S BCS	900038	E
	Adapter for handgrip Fits ITX MU15 (REF 418203)	AH-MU	900041	F
  	Hex Instrument 1.25, length 14 mm	HTS 1.25	425101	C
	Hex Instrument 1.25, length 21 mm	HT 1.25	425100	C
	Hex Instrument 1.25, length 45 mm	HTX 1.25	425102	C
	Scan abutment for MU implants Incl. screw SSA MU Sterilisable, two-part, material Ti6Al4V	SAB MU	418205	D
Parts for passive connection of the bridge frame	Prosthetic screw for KOS® MU and BCS® MU	SF K MU	418164	B
	Castable abutment Use with T-Base and SF K MU	PA2 MU	418189	B
	Titanium base* Use with SF K MU (REF 418164) For KOS® MU, BCS® MU and Hexacone® Plus MU	T-Base MU	418188	B
Parts for UCLA technique	Prosthetic screw For KOS® MU and BCS® MU	SF K MU	418164	B
	Castable abutment UCLA For direct use on MU implants SF K MU sold separately	PA MU	418119	B
Part for UCLA technique & passive connection	Digital lab analogue for MU implants* For KOS® MU, BCS® MU and Hexacone® MU	IA K MU	418159	B
  	Long screw for prosthetic use or as pick-up screw for use with HLT MU Tool: HT 1.25, material Ti6Al4V	SFL MU	418168	B
	Transfer for pick-up impressions Straight Delivery incl. SFL MU	HLT MU	418162	C
	Temporary base SF K MU or SFL MU sold separately	TC MU	418161	D

EXTENSION SET FOR KOS® TRAY

Works with all MU implants

APPLICATION OF SINGLE-PIECE MULTI-UNIT IMPLANTS

1.

Tighten screw SFL MU with the tool HT 1.25.

Fix the transfer with the long screw, then take pick-up-imp-
ression.

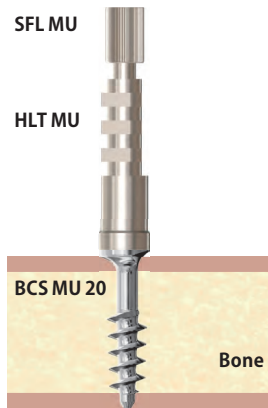

4.

T-Base is sandblasted **from the outside** and cleaned.

The bridge frame is sandblasted **from below in the area of the implants.**



2.

Connect the transfer to the im-
plant analogue (IA K MU) and
pour the impression with gyp-
sum.

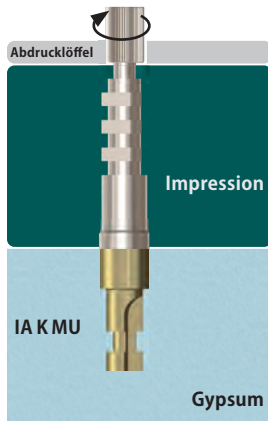

5.

All T-Base are fixed to the im-
plants with SF K MU or the long
screw SFL MU. Then all T-Base
are glued with adhesive cement
to the bridge frame.

This guarantees a passive fit.
Composite excess is removed
and the site is polished.



3. a

Connect PA MU with SF K MU on
the analogue IA K MU. Tighten
screw SFL MU with the tool HT
1.25.

Now the modulation can be
created and the frame is veneer-
ed. Veneering is possible with
acryl, composite and ceramics.

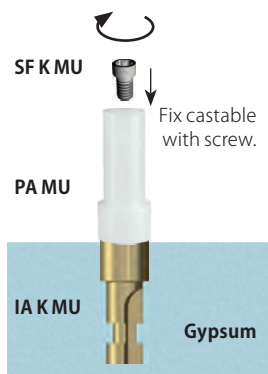

6.

Now the bridge may be scre-
wed on passive with SF K MU.

Screw canals are closed with
temporary filling material or
composite, taking into consid-
eration that later access must be
possible.

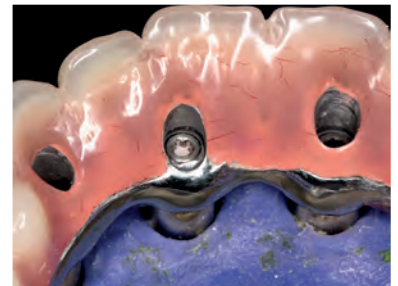

3. b

T-Base is positioned over the
analogue and screwed on with
SF K MU. The cartable PA2 MU is
then fitted on top of the T-Base.

Now the modulation is made.
Veneering is possible with acryl,
composite and ceramics.

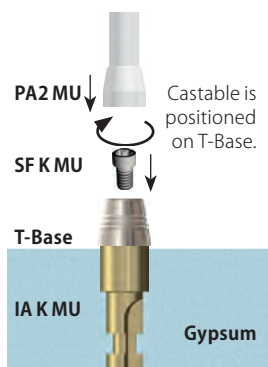
Application
of insertion tool MU

Example for insertion
tool ITX MU15 on the
implant BCS® MU /
KOS® MU.

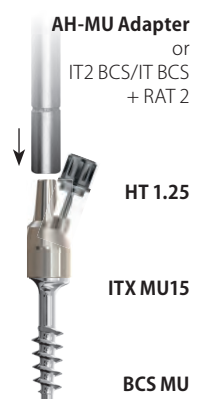

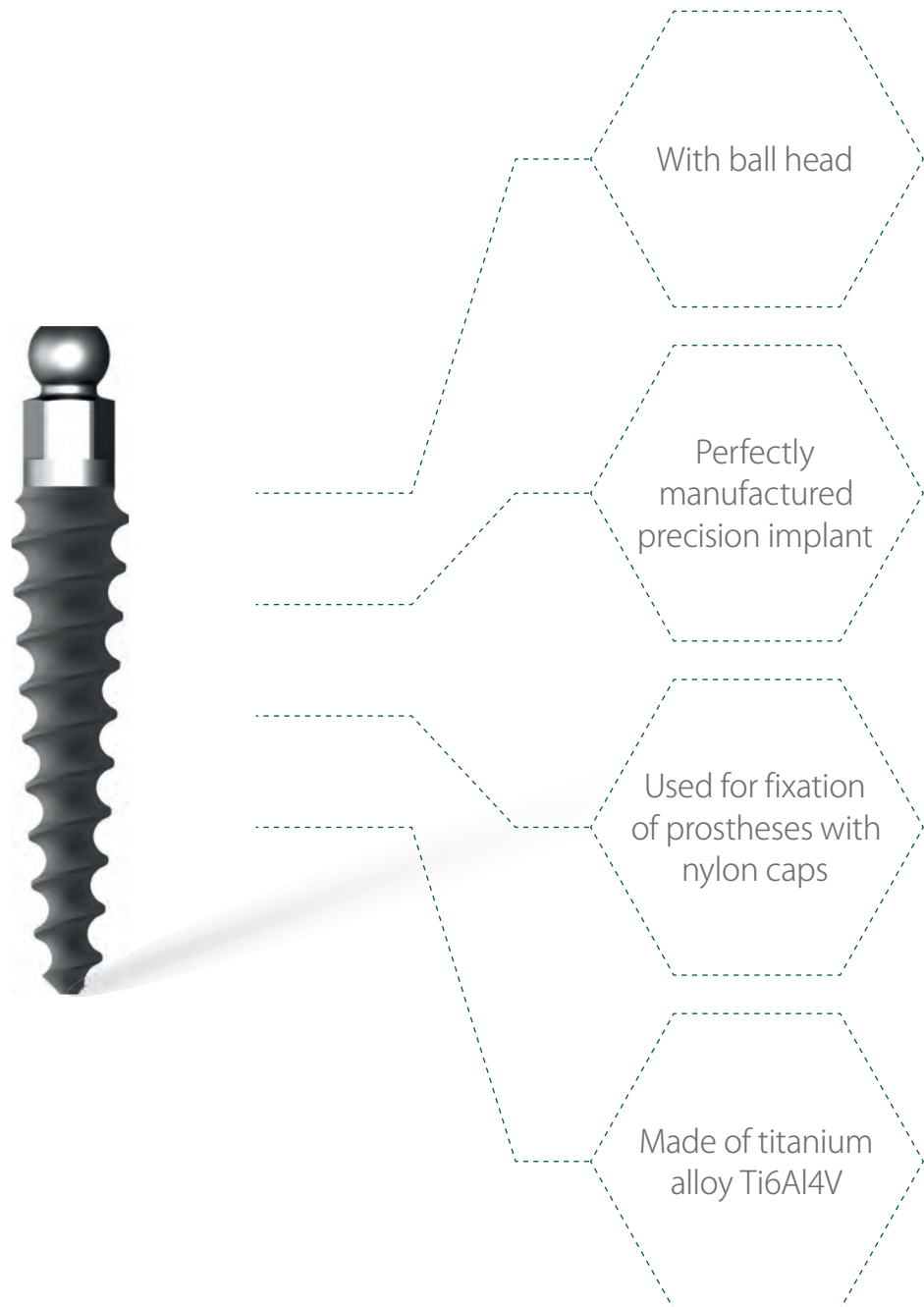
THE ADVANTAGES OF KOS® K IMPLANTS

KOS® K IMPLANTS

Perfectly manufactured precision implant made of highly fracture-resistant titanium alloy Ti6Al4V.
KOS® K implants with ball head are used for fixation of prostheses with nylon caps.

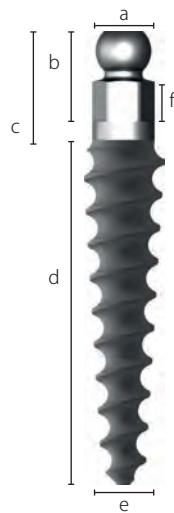

Description	Code KDS	Enossal Ø	Enossal length	REF	Price cat.
KOS K 3.0 12	B	3.0 mm	12 mm	455152	F
KOS K 3.0 15	C	3.0 mm	15 mm	455150	F
KOS K 3.7 12	F	3.7 mm	12 mm	455154	F
KOS K 3.7 15	G	3.7 mm	15 mm	455155	F
KOS K 4.1 15	L	4.1 mm	15 mm	455156	F

a) Ball head Ø	2.5 mm
b) Abutment height	4.1 mm
c) Length	5.6 mm
d) Enossal length	12 - 15 mm
e) Enossal Ø	3.0 / 3.7 / 4.1 mm
f) Height of hexagon	1.8 mm

ACCESSORIES

Description	Unit	Code	REF	Price cat.
 IAK Lab analogue		IAK	455180	B
 Nylon cap transparent, Pull-off force ca. 1200g (EXTERNAL PRODUCT)	Pack of 2	NC	465028	A1
 Nylon cap pink, Pull-off force ca. 800g (EXTERNAL PRODUCT)	Pack of 2	NC 1	465029	A1
 Nylon cap yellow, Pull-off force ca. 500g (EXTERNAL PRODUCT)	Pack of 2	NC 2	465030	A1
 Green, strong Nylon caps R-NC With increased friction strength Only with reduced diameter ball ≤ 2.3 mm	Pack of 2	R-NC	465034	A1
 Pink, medium (EXTERNAL PRODUCT)	Pack of 2	R-NC 1	465033	A1
 Orange, soft	Pack of 2	R-NC 2	465032	A1
 Metal sleeve for all nylon caps (EXTERNAL PRODUCT)		H	465031	B
 Giessbare Kugel for einteiligen Abdruck with Stegverbindung		PASB		A

BALL ADAPTER (SPARE BALL)



Description

Ball adapter for KOS® K implants, cementable

REF

462051

Price cat.



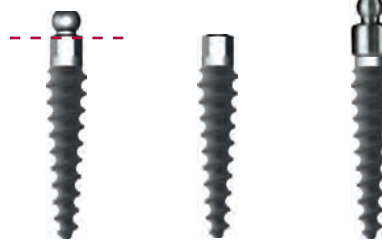

B



INSERTION TOOLS



	Description	Type	Length	Code	REF	Price cat.
	For KOS, KOS B, KDS	long	20 mm	IT K	462320	D
	For KOS, KOS B, KDS	extralong	45 mm	ITX K	462321	D
	For KOS, KOS B, KDS	short	7 mm	ITS K	462322	D
	For KOS, KOS B, KDS Only for W&H contra-angle with new drive	contra-angle/ hex	23 mm	ITWH K	462323	D
	For KOS, KOS B, KDS	contra-angle	23 mm	ITW K	462331	D
	For KOS K	long	20 mm	IT TB K	462327	D
	For KOS B Emergency tool for retrieving KOS® B	long	20 mm	Tool E	462377	D

INSTRUMENTS AND TOOLS

	Description	Length	Code	REF	Price cat.
	Drill extension Extends by 19 mm		DX 2	500704	D
	Standardized probe. 1 mm scale For radiological measurements	22 mm	PDG	425400	A
	Radiological measure pin Fits DOS 1		CDG	420329	A
	Ratchet for all Hex instruments and insertion tools		RAT 2	425051	K
	Torque wrench 10-70 Ncm		TW2 *	425402	S

* It is recommended to have the torque ratchets recalibrated by us once a year.

HARD METAL BONE CUTTER



	Description	Length	Code	REF	Price cat.
	Hard metal bone cutter short, for FG	30 mm	SHMCS	90030	F
	Hard metal bone cutter long, for FG	36 mm	SHMCL	90031	F

HANDGRIP SELF LOCKING





For machine reprocessing, cannot be dismantled. Clean in an ultrasonic bath at 45° with an alkaline cleaning agent. For adapter, self-locking. Please note the cleaning instructions on www.implant.com/en/downloads



DRILLS

	Description	Length	Code	REF	Price cat.
	Adapter	100 mm	BCD 1 Adapter	310511	F
	Twist Drill	110 mm	Twist Drill 2.0	310512	F

INSERTION TOOLS

	Description	Length	Code	REF	Price cat.
 	For KOS®, KOS® B, KDS, BCS 3.5, BCS 4.5	70 mm	Adapter AHK	462319	D
 	For KOS® X, KOS® TX, KOS® Plus, BCS 3.6, BCS 4.6, ab > 5.5	70 mm	Adapter AHB	900037	F

HANDGRIP TRAY

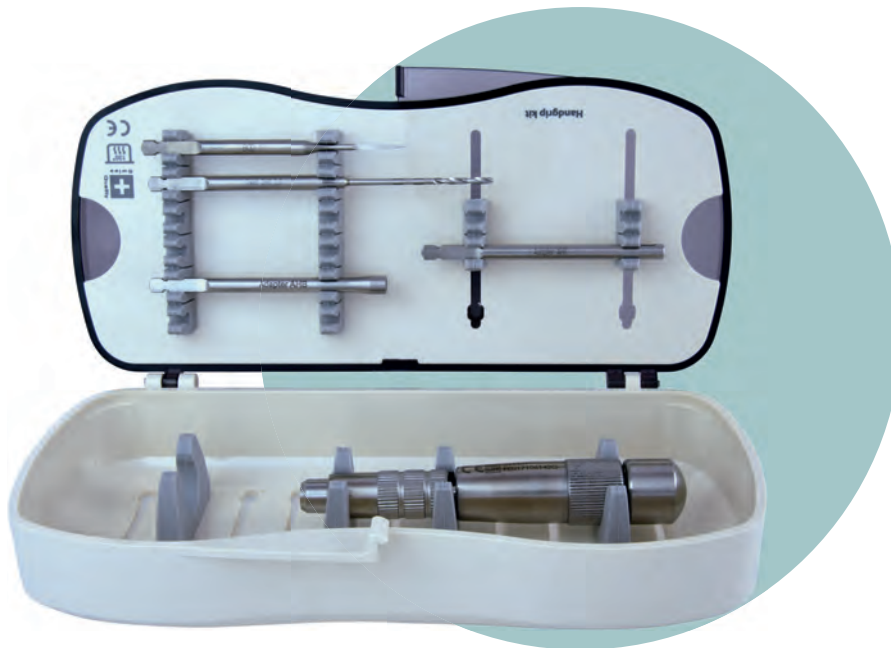

Size of closed tray
W 195 mm **D** 90 mm **H** 45 mm
 For all autoclaves

Description

BCD 1 Adapter
 Twist Drill 2.0
 Adapter AHK
 Adapter AHB
 Handgrip

Handgrip tray w/o content
Handgrip tray with content

Length	REF	Price €
100 mm	310511	
110 mm	310512	
70 mm	462319	
70 mm	900037	
110 mm	311431	
	60043	upon request
	560043	upon request

Please read our detailed instructions for cleaning and re-sterilization of surgical instruments on
<https://implant.com/en/downloads>

INSTRUMENT TRAY FOR KOS® AND BCS®



Size of closed tray

W 175 mm **D** 145 mm **H** 65 mm

For all autoclaves. Autoclaveable up to 134° C,
not suitable for dry heat sterilizers.

Description	System	Head	REF	Description	System	REF	Price €
IT2 BCS	KOS/BCS	large	900030	Twist Drill 2.0 30	BCS *	90020	
IT2 S BCS	KOS/BCS	large	900038	Twist Drill 2.0 21	BCS *	90022	
IT2 W	KOS/BCS	large	900039	Twist Drill 2.5 21	BCS *	90026	
IT K	KOS/BCS	small	462320	BCD 1	KOS/BCS	900240	
ITS K	KOS/BCS	small	462322	BCD 2	KOS/BCS	900241	
ITW K	KOS/BCS	small	462331	BCD 3	KOS/BCS	900242	
ITWH K	KOS/BCS	small	462323	BCDX 1	KOS/BCS	900243	
DOS 1	KOS		455311	BCDX 2	KOS/BCS	900244	
DOS 2	KOS		455312	BCDX 3	KOS/BCS	900245	
DOS 3	KOS		455313	CDG	KOS/BCS	420329	
DOS 4	KOS		455314	CDG	KOS/BCS	420329	
DOS 5	KOS		455315	DX 2	KOS/BCS	500704	
C-Drill KM 1	KOS		455300	TW2	KOS/BCS	425402	
C-Drill KM 2	KOS		455301				
C-Drill KM 3	KOS		455302	Instrument tray w/o content	60006-K		upon request
DS 2	KOS		425001	Instrument tray with content	S60006-K		upon request
IT TB K	KOS		462327				

* The content for the system BCS® is optional

DRILLSTOP TRAY

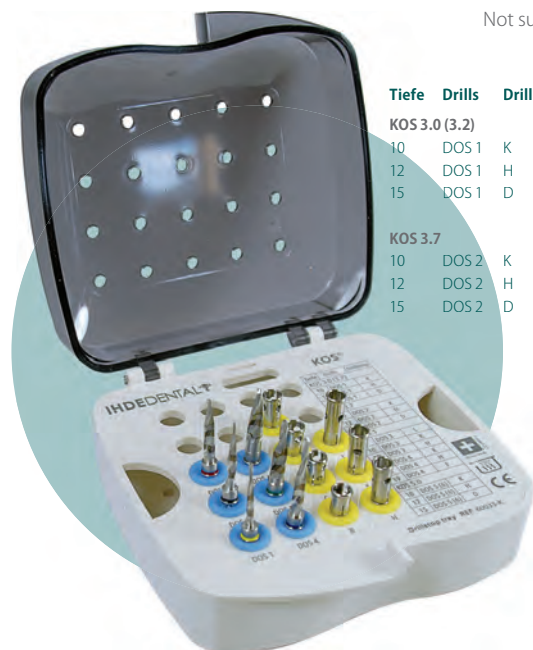

Not suitable for dry heat sterilizers

Tiefe	Drills	Drillstop	Tiefe	Drills	Drillstop
KOS 3.0 (3.2)			KOS 4.1		
10	DOS 1	K	8	DOS 3	L
12	DOS 1	H	10	DOS 3	K
15	DOS 1	D	12	DOS 3	H
KOS 3.7			15	DOS 4	K
10	DOS 2	K	17	DOS 4	H
12	DOS 2	H	19	DOS 4	F
15	DOS 2	D	KOS 5.0		
			10	DOS 5 (6)	K
			12	DOS 5 (6)	H
			15	DOS 5 (6)	D

Description	REF	Price €
Drillstopp B	500882	
Drillstopp C	500883	
Drillstopp D	500884	
Drillstopp F	500886	
Drillstopp H	500888	
Drillstopp K	500891	
Drillstopp L	500892	
Drill DOS 1	455311	
Drill DOS 2	455312	
Drill DOS 3	455313	
Drill DOS 4	455314	
Drill DOS 5	455315	
Drill DOS 6	455316	
Tray with content	60033-K	498.00

IT HAS BEEN SCIENTIFICALLY PROVEN

Heatless® drills by Dr. Ihde Dental generate 55% less heat than traditional bone drills from other manufacturers. This makes it possible to use higher rotational speeds: between 3,000 and 5,000 rpm are recommended with good external cooling and intermittent drill technique.

STARTER TRAY



Autoclaveable up to 134° C,
not suitable for dry heat sterilizers.
This surgical kit contains all drills and
tools for first works with the system KOS®.
Material: autoclaveable plastic.

Description	REF	Price €
IT K	462320	
ITS K	462322	
C-Drill KM 1	455300	
C-Drill KM 2	455301	
C-Drill KM 3	455302	
IT 2 BCS	900030	
IT 2 S BCS	900038	
DOS 1	455311	
DOS 2	455312	
DOS 3	455313	
BCDX 1	900243	
Torque wrench TW2	425402	
HT 1.25	425100	optional content
ITX MU 15	418203	
Starter tray w/o content	60041-K	
Starter tray with content	S60041-K	upon request

INDICATIONS **KOS®** II **KOS®** MICRO

- Anchorage of crowns, bridges and bars, with the presence of adequate bone supply in terms of bone quality, bone width and bone height
- Anchorage of prostheses via bar and button anchorage systems
- Not for use in combination with simultaneous bone augmentations

RESTRICTIONS FOR **KOS® B** APPLICATION

- These two implant types may only be used as support implants in the reduced-load area
- Splinting of at least three and possibly several implants for cross arch stabilisation
- At least one **KOS®** or **KOS® Micro** implant must be involved in the construction
- The prosthetic restoration must be securely fixed (with definitive cements)
- Not to be used for segmented bridges without the involvement of at least two **KOS®** screws
- If in doubt, angulation adapters on **KOS®** screws are preferable to the **KOS® B** implant
- Not to be used for additional abutments in combination with natural teeth
- Not to be used under off-axis load as well as in deep-bite cases in the maxillary and mandibular anterior region
- Max. width of occlusal surface 5 mm
- Not to be used as terminal abutments
- Bendable up to 13 degrees

NOTES ON THE CARE OF SURGICAL STEEL INSTRUMENTS

Surgical steel instruments can quickly become damaged if inadequately or improperly cared for. Only the special solvents for cleaning surgical steel should be used; in case of doubt, consult **Dr. Ihde Dental GmbH / AG**.

The following are not recommended:

- Disinfectants/cleaners with a high chlorine content
- Disinfectants/cleaners with a high oxalic acid content

For instruments with colour coding, the following are NOT recommended:

- Excessively high solvent concentrations, disinfectants/cleaners with the components mentioned above
- Excessive temperatures during cleaning and sterilization (no dry heat sterilization)

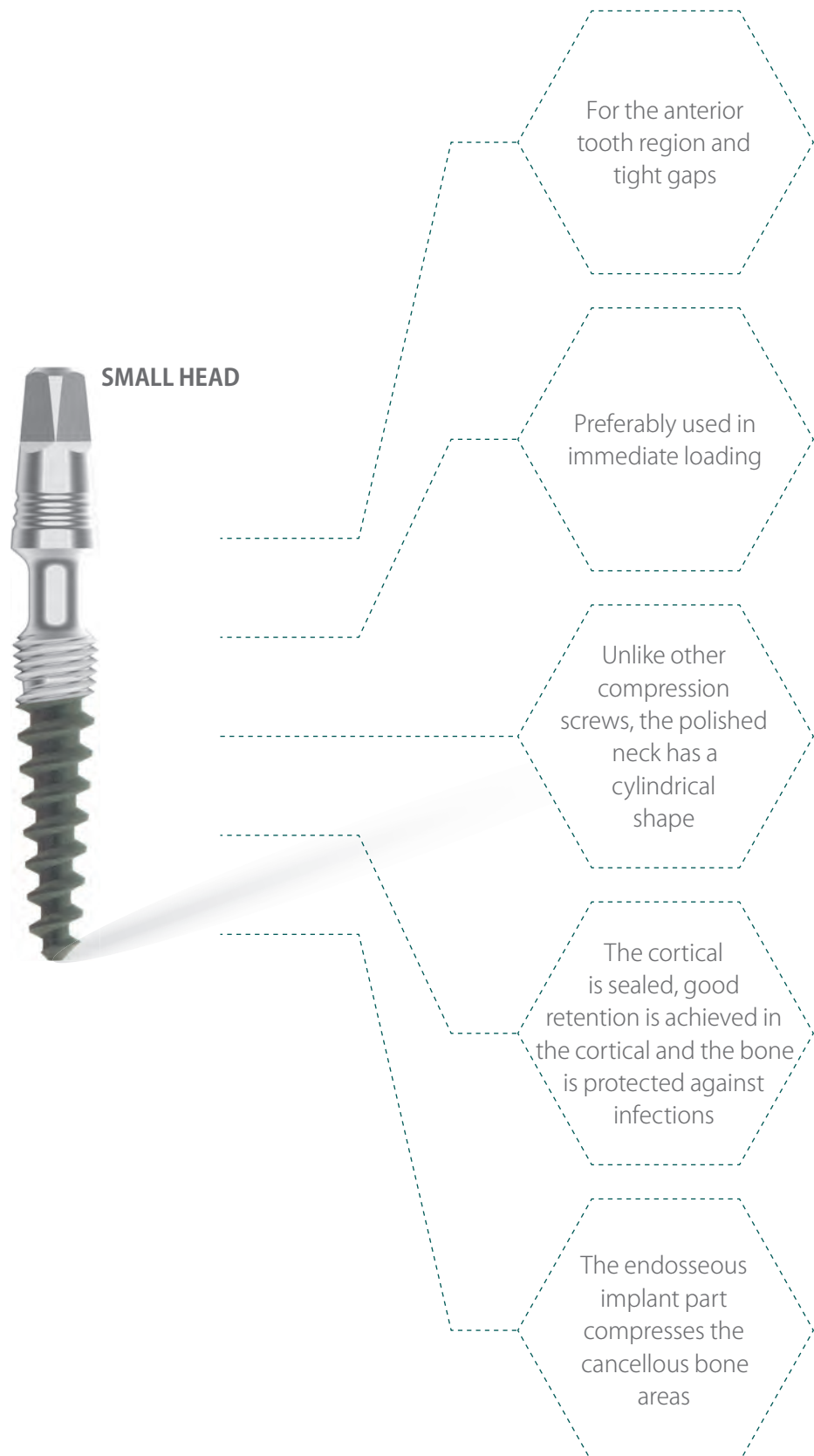
THE ADVANTAGES OF KOS® M IMPLANTS

KOS® M AND MICRO IMPLANTS

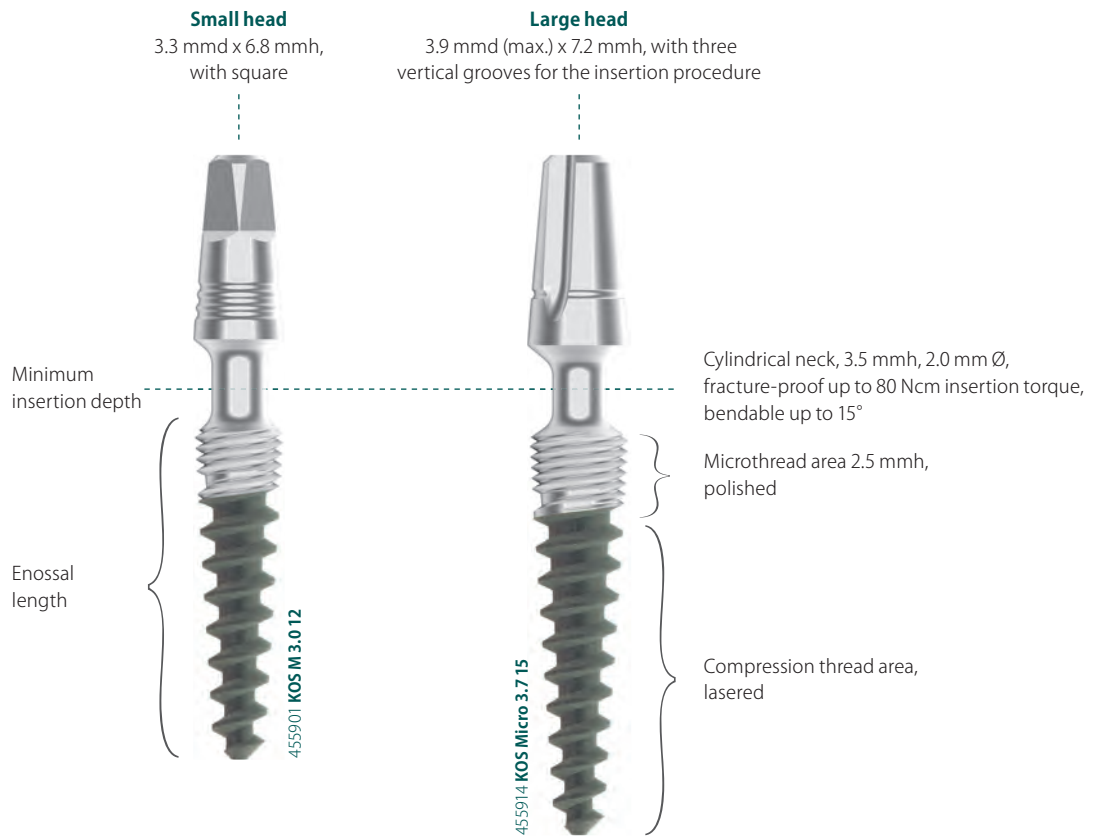

MATERIAL

Ti6AL4V, also known as „Grade 5“, is the high-purity version of the conventional 6/4 Ti alloy, which is used for more than 50% of all metallic human implants. This material is the first choice for all applications which require high stability, corrosion resistance and mechanical strength. This is why today's most modern dental implant designs are made of this material. This titanium alloy is superior to the alternatively used pure titanium in terms of stability by more than 25%. Also regarding biocompatibility and the support of bone cell growth, this titanium alloy shows advantages compared to pure titanium.

FUNCTIONALITY

The one-piece **KOS® M / KOS® Micro** dental implant is preferably used in immediate loading. Unlike other compression screws, the polished neck has a cylindrical shape. Thus, the cortical is sealed, good retention is achieved in the cortical and the bone is protected against infections. At the same time, the endosseous implant part compresses the cancellous bone areas.

NOTE The smooth microthread must be completely submerged below the bone level. The cylindrical neck must extend into the bone at least 1 mm deep. Therefore, the implant must be selected so that at least 1.5 mm more usable vertical bone is present than the nominal length of the implant. **Example** For KOS Micro 3.7 15, 17 mm of usable vertical bone must be present. If in doubt, a shorter implant should be selected so as to ensure a sufficient insertion depth.

DRILLING PROCEDURE

The pilot hole is made with the drills of the KOS® system. Except in very dense mandibular bone, the pilot hole is usually sufficient with BCD1 or DOS1.

INSERTION

The implant can be inserted most easily with the handgrip (REF 311431) and the adapter (REF 900 037). When using the ratchet RAT2, small or medium insertion tools are used. Max. torque is 80 Ncm.

THE IMPLANTS ARE SUPPLIED WITH TWO DIFFERENT HEAD SIZES

KOS® M implants are supplied with a small head; they also fit in small individual tooth gaps.

KOS® Micro implants are supplied with a large head. This head permits easy and speedy prosthetic restoration.

KOS® M IMPLANTS WITH SMALL ABUTMENT HEAD

KOS® M with small head for the anterior tooth region and tight gaps. Material Ti6Al4V.

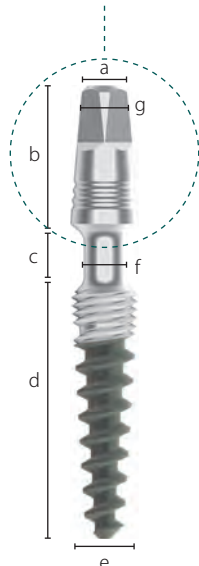

Description	Enossal Ø	Enossal length	Neck Ø	Drill *	REF	Price cat.
KOS M 3.0 10	3.0 mm	10 mm	2 mm	DOS 1 or BCD 1	456108	F
KOS M 3.0 12	3.0 mm	12 mm	2 mm		456109	F
KOS M 3.0 15	3.0 mm	15 mm	2 mm		456110	F
KOS M 3.2 12	3.2 mm	12 mm	2 mm		456111	F
KOS M 3.2 15	3.2 mm	15 mm	2 mm	DOS 2 or BCD 2	456112	F
KOS M 3.7 6	3.7 mm	6 mm	2 mm		456106	F
KOS M 3.7 8	3.7 mm	8 mm	2 mm		456107	F
KOS M 3.7 10	3.7 mm	10 mm	2 mm		456114	F
KOS M 3.7 12	3.7 mm	12 mm	2 mm		456115	F
KOS M 3.7 15	3.7 mm	15 mm	2 mm	456120	F	

* In very hard bone, it may be additionally necessary to make a cylindrical hole with a twist drill 2.5 mm to a depth of 2.5 mm.

a) Abutment Ø	3.35 mm
b) Abutment height	6.8 mm
c) Neck length	3.5 mm
d) Enossal length	6 - 15 mm
e) Enossal Ø	3.0 - 3.7 mm
f) Neck Ø	2.0 mm
g) Square AF (across flats)	1.9 mm

Max. insertion torque 80 Ncm



INCLUSIVE

KOS® implants are delivered incl. lab-set REF 462353, consisting of



Double analogue, plastic

IA4/IAU

462111



Impression post castable, internally edged, for large head

PA X

462136



Impression post castable, internally round, for small head

TSPA 4

462029

NOTE This is a standard lab-set and therefore contains parts for both **LARGE** abutment heads (**PA X**) and **SMALL** abutment heads (**TSPA 4**).

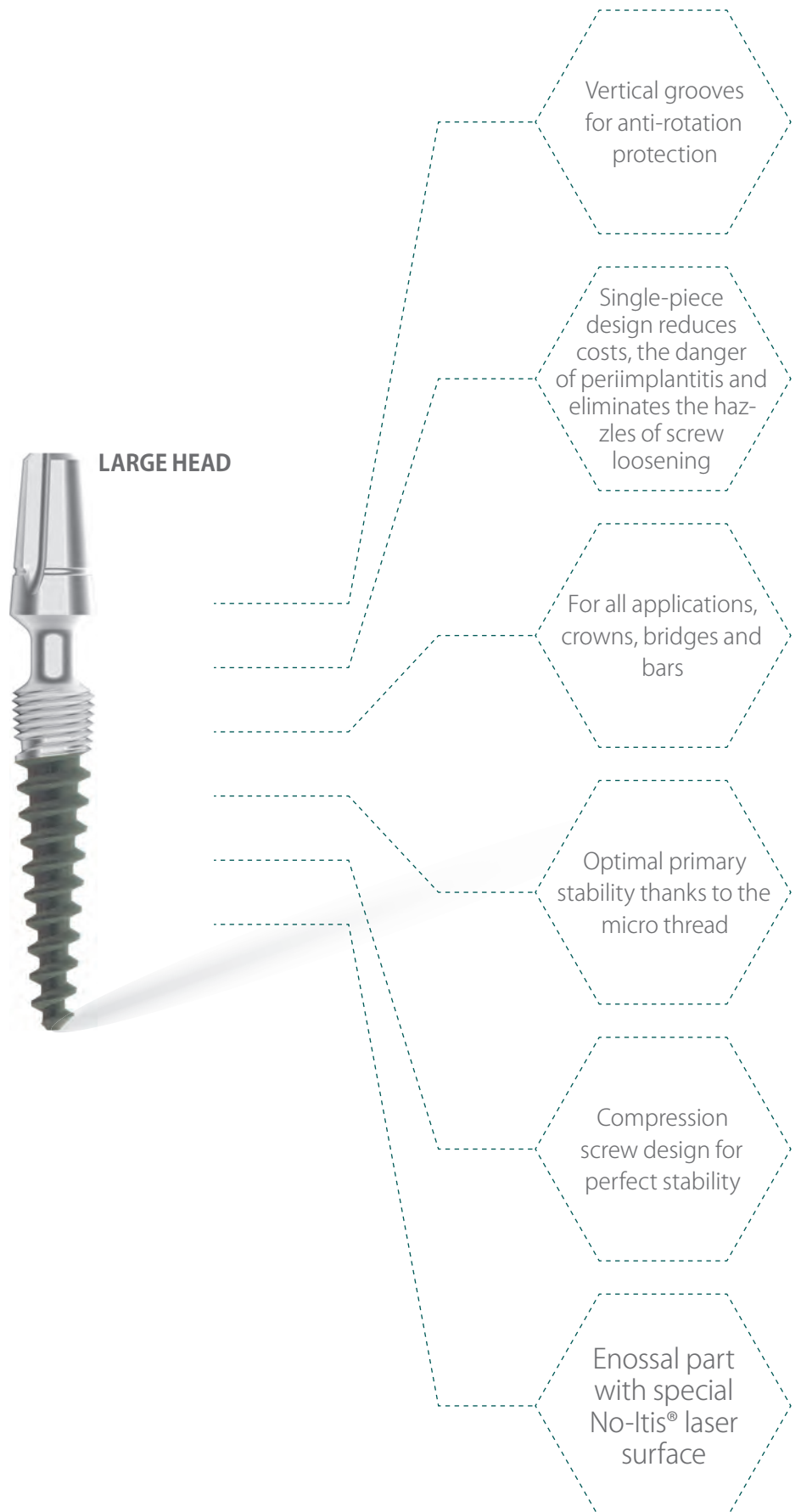
THE ADVANTAGES OF KOS® MICRO IMPLANTS

KOS® MICRO IMPLANTS WITH LARGE ABUTMENT HEAD

KOS® Micro with large head for all applications. Material Ti6Al4V.

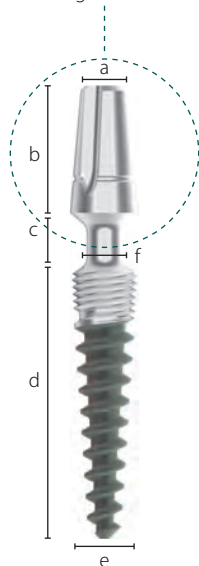

Description	Enossal Ø	Enossal length	Neck Ø	Drill *	REF	Price cat.
KOS Micro 3.7 6	3.7 mm	6 mm	2.0 mm	DOS 2 or BCD 2	455910	F
KOS Micro 3.7 8	3.7 mm	8 mm	2.0 mm		455911	F
KOS Micro 3.7 10	3.7 mm	10 mm	2.0 mm		455912	F
KOS Micro 3.7 12	3.7 mm	12 mm	2.0 mm		455913	F
KOS Micro 3.7 15	3.7 mm	15 mm	2.0 mm	DOS 3 or BCD 3	455914	F
KOS Micro 4.1 8	4.1 mm	8 mm	2.0 mm		455920	F
KOS Micro 4.1 10	4.1 mm	10 mm	2.0 mm		455921	F
KOS Micro 4.1 12	4.1 mm	12 mm	2.0 mm	DOS 5	455922	F
KOS Micro 4.1 15	4.1 mm	15 mm	2.0 mm		455923	F
KOS Micro 5 10	5.0 mm	10 mm	2.0 mm	DOS 5	455925	F
KOS Micro 5 12	5.0 mm	12 mm	2.0 mm		455926	F

* In very hard bone, it may be additionally necessary to make a cylindrical hole with a twist drill 2.5 mm to a depth of 2.5 mm.

- a) Abutment Ø 3.9 mm
- b) Abutment height 7.2 mm
- c) Neck length 3.5 mm
- d) Enossal length 6 - 15 mm
- e) Enossal Ø 3.7 - 5.0 mm
- f) Neck Ø 2.0 mm

Max. insertion torque 80 Ncm



INCLUSIVE

KOS® implants are delivered incl. lab-set REF 462353, consisting of



Double analogue, plastic
IA4/IAU
462111





Impression post castable,
internally edged, for large head
PAX
462136



Impression post castable,
internally round, for small head
TSPA 4
462029







ACCESSORIES

Analogue **IAB**  Impression post **TSPA 5** 
Pack of 5 Pack of 5
REF 462106 **REF 462030**
Price cat. B **Price cat. B**

The red impression cap and the red analogue are round (not secured against rotation).



NOTE This is a standard lab-set and therefore contains parts for both **LARGE** abutment heads (**PA X**) and **SMALL** abutment heads (**TSPA 4**).

IMPRESSION TAKING AND LABORATORY ACCESSORIES

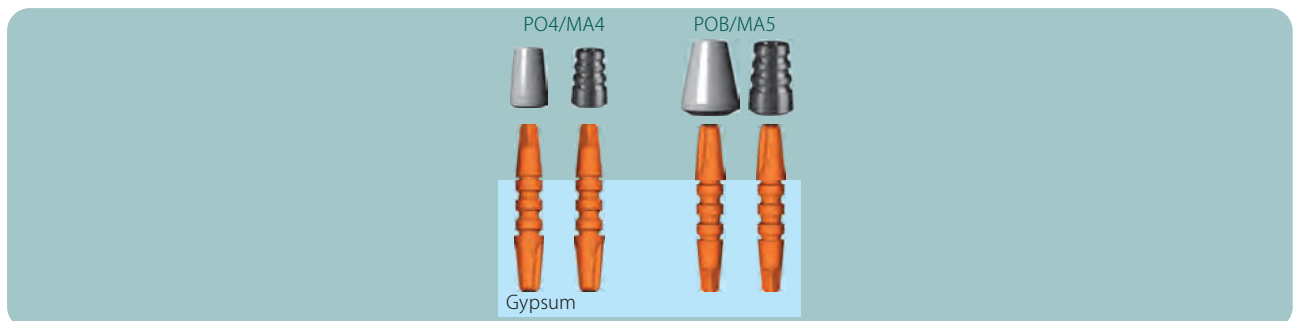

		Description	Unit	Code	REF	Price cat.
FOR SMALL HEAD		Impression post castable, POM Internally round	Pack of 5	TSPA 4	462029	B
		ALTERNATIVE Impression post castable, POM Internally round	Pack of 5	TSPA 4	462027	B
		Castable abutment and base for provisionals For small head 7 mm high, white, internally round	Pack of 5	PO4	462088	B
		Double analogue, plastic For large and small head	Pack of 5	IA4/IAU	462111	B
		Double analogue, metal For large and small head	1 piece	IA4/IAU	462112	A
FOR LARGE HEAD		Impression post castable, Internally edged	Pack of 5	PAX	462136	B
		Castable abutment for large head Internally round	Pack of 5	POB	462086	B



TITANIUM CAPS

	Description	Material	Code	REF	Price cat.
	Titanium cap, radio opaque For small head	Ti6Al4V weldable	MA4	462090	B
	Titanium cap, radio opaque For large head	Ti6Al4V weldable	MA5	462093	B

CORTICAL MILLING FOR KOS® M AND KOS® MICRO

	Description		Code	REF	Price cat.
	C-Drill KM1 3.0 - 3.2	Cortical milling	C-Drill KM1	455300	E
	C-Drill KM2 3.7 - 4.1	Cortical milling	C-Drill KM2	455301	E
	C-Drill KM3 5.0	Cortical milling	C-Drill KM3	455302	E

SCANBODIES MATERIAL PEEK/POM



Description Scanbody-4
Cylindrical, for small head

Systems KOS®, BCS®

REF 462054

Price cat. B (Pack of 5)



Description Scanbody-5
Cylindrical, for large head

Systems KOS®, BCS®

REF 462055

Price cat. B (Pack of 5)



View from top



Description Scanbody-MU
Cylindrical

Systems KOS® MU, BCS® MU,
Hexacone® MU

REF 462056

Price cat. B (Pack of 5)



Description Flag-Scanbody **SCB4**
For small head
For intra-oral scans

Systems KOS®, BCS®

REF 462071

Price cat. C (Pack of 5)



Description Flag-Scanbody **SCB5**
For large head
For intra-oral scans

Systems KOS®, BCS®

REF 462072

Price cat. C (Pack of 5)



View from top



Description Flag-Scanbody **SCB MU**
Incl. screw SFK MU (418164)
For intra-oral scans

Systems KOS® MU, BCS® MU,
Hexacone® MU

REF 462073

Price cat. B (1 piece)

Please go to <https://implant.com/en/downloads> to download the corresponding STL files.

HEATLESS® DRILLS DOS FOR IMPLANTS WITH CONICAL CORE

Surgical steel, colour-coded, depth-coded and autoclaveable. The drill is marked with laser depth markings.
Use between 3,000 and 5,000 rpm with good cooling and intermittent drill technique.
Due to the extremely high cutting performance, you can work without pressure.











-55%
heat



Description	Colour	Max. working length	REF	Price cat.
DOS 1	yellow	17 mm	455311	D
DOS 2	black	17 mm	455312	D
DOS 3	red	17 mm	455313	D
DOS 4	blue	21 mm	455314	D
DOS 5	green	17 mm	455315	D
DOS 6	transparent	15 mm	455316	D

DOS 6 This drill is 2 mm shorter at the tip. It can therefore drill up to 2 mm deeper into hard bone than nominally indicated on the drill. Therefore, the conical bone cavity is only circularly extended in the crestal area without increasing the drilling depth.

INSTRUMENTS AND TOOLS

Description	Length	Code	REF	Price cat.
 Insertion tool short, for large head Use with RAT 2 and TW2	7 mm	IT2 S BCS	900038	E
 Insertion tool long, for large head Use with RAT 2 and TW2	19 mm	IT2 BCS	900030	E
 Insertion tool for large head Use with contra-angle	23 mm	IT2W	900039	E
 Insertion tool long, for small head Use with RAT 2 and TW2	20 mm	IT K	462320	D
 Insertion tool short, for small head Use with RAT 2 and TW2	7 mm	ITS K	462322	D
 Insertion tool for small head Use with contra-angle	23 mm	ITW K	462331	D
 Torque wrench 10 - 70 Ncm		TW2	425402	S
 Adapter for large head Use with handgrip	70 mm	AHB	900037	F
 Adapter for small head Use with handgrip	70 mm	AHK	462319	D
 For machine reprocessing, cannot be dismantled Clean in an ultrasonic bath at 45° with an alkaline cleaning agent For adapter, self-locking	110 mm		311431	V

Heatless® Drill
DOS 1 REF 455311

Heatless® Drill
DOS 2 REF 455312

Heatless® Drill
DOS 3 REF 455313

Heatless® Drill
DOS 4 REF 455314

Heatless® Drill
DOS 5 REF 455315



Twist Drill
ø 2.0 mm

Twist Drill
ø 2.0 mm

Twist Drill
ø 2.0 mm

Twist Drill
for ZSI

Twist Drill
for ZSI

Twist Drill
for ZSI

Twist Drill 2.0/21
REF 90022

Twist Drill 2.0/30
REF 90020

Twist Drill 2.0/40
REF 90019

Twist Drill 2.2 /50
REF 90021

Twist Drill 2.2 /55
REF 90023

Twist Drill 2.2
REF 310514



REPROCESSING OF TOOLS AND DRILLS

EN

MANUFACTURER'S INFORMATION regarding the preparation of reusable medical devices complies with EN ISO 17664

Please read carefully!

Medical devices which may be re-processed are

- tools for abutments and screws
- torques control instruments and ratchets
- Instruments for preparing endosseous bone cavities (drills, cutters)
- Bone expansion screws and distractors
- Drill guide sleeves
- Abutments and screws, provided they do not remain in with the patient between individual treatment appointments and are not used on other patients. They should be stored by the operator between the treatment appointments, e.g. together with the patient's file.
- Manual instruments for the placement of implants and bone preparation.

Re-usability

Frequent re-processing has influence on the product especially if high temperatures are applied for sterilisation. Drills for bone cavities should be used only 10 times. Tools and ratchets may be used as long as they fit to the 2nd part in general, the operator is responsible for the decision of re-using and re-processing of instruments. Damaged instruments and instruments showing signs of wear must be discarded. Liability of the manufacturer is void, if these restrictions are not regarded.

Legal bases

- The following legal bases, regulations and recommendations are applied with regard to the products mentioned above: (Germany)
- Directive 93/42 EEC
 - Medical device regulations (which is valid in the country where the instrument is used for treatment or where the functionality of the medical device is being evaluated)
 - Bundesgesundheitsblatt (Federal Health Gazette) 2001: 44: 115-112

Hygiene requirements for the processing of medical devices (Recommendation of the Commission for Hospital Hygiene [Kommission für Krankenhaushygiene] at the Robert-Koch Institute and the Federal Ministry for Drugs and Medical Devices [Bundesministerium für Arzneimittel und Medizinprodukte]).

Legal information

Implants and other components of the implant system (Disks, RO, RC, RECES, GBC as well as KOS PLUS (basal) implants according to the Consensus on basal/strategic implants as issued by the International Implant Foundation/Munich, see www.iiifoundation.org/en/consensus-papers) are sold only to licensed practitioners with valid authorisation of the manufacturer (or issued by the IF) for the use of the system. This demand for further and continuous education is also valid for advising patients before and after the placement of the implants.

General principles

All reusable products must be cleaned, disinfected and sterilised before each use. This also applies to the initial use of products that are supplied nonsterile. Efficient cleaning and disinfection is essential for effective sterilisation. Special cleaning/sterilisation instructions should be obtained from the instructions for use. The operating instructions of the practice units must also be observed. As the operator is responsible for the sterility of instruments during use, please ensure that only adequate, validated parameters specific to the unit and product are constantly maintained during each cycle. Please also observe all valid legal and hygiene regulations of the dental practice and dental hospital. This applies in particular to the different guidelines regarding effective infection prevention. Important: Always wear protective gloves for your own safety when handling contaminated instruments!

- Instruments from different materials should never be disinfected, cleaned or sterilised together. This also applies when using an ultrasonic cleaner.
- During mechanical cleaning, instruments should be arranged so that they cannot come into contact, as otherwise there is the risk of damage.
- Multi-part instruments such as ratchets, trephine drills, screw drivers etc. should be disassembled into their component parts and these should be individually disinfected, cleaned or sterilised.
- These instruments should also be stored disassembled until the next use.

Care instructions of surgical steel instruments

Surgical steel instruments can quickly become damaged with inadequate or incorrect care. Only commercially available solvents should be used for surgical steel. If in doubt contact **Dr. Ihde Dental AG**.

The following are not recommended:

- Disinfection/cleaning agent with a high chlorine content
- Disinfection/cleaning agent with a high oxalic acid content
- The following are not recommended for instruments with colour coding
- Too high solvent concentrations, disinfection/cleaning agent with the ingredients mentioned above
- Too high temperatures with mechanical cleaning and sterilisation; never higher than 135° C

Conditioning

Coarse impurities must be removed from the products immediately after use (within 1-2 hrs maximum). Surgical residue (blood, secretions, tissue residue) should not be allowed to dry on the products. Instruments should be placed in a disinfectant solution immediately after surgery. For temporary storage and pre-disinfection/cleaning immediately after use on patients the instruments can be placed in an interim stand filled with a suitable cleaning/disinfection agent. Contamination should then be cleaned from the instruments under running water or in a disinfectant solution; the disinfectant should be aldehyde-free (otherwise fixation of blood and contamination), have proven efficacy (e.g. DGHM [German Society for Hygiene and Microbiology]/ FDA approved and CE Mark), be suitable for instrument disinfection and compatible with the instruments [see section "Material compatibility"]. Follow the disinfectant instructions for use. For manual removal of contamination use only a clean, soft brush or a clean soft cloth which is used specifically for this purpose. Never use metal brushes or steel wool.

- Please note that the disinfectant used for conditioning is only for personal protection and cannot replace the subsequent disinfection step to be performed after cleaning.
- Never allow instruments to remain wet or moist for a longer period of time.
- Corroded, rusty instruments must be cleaned in an ultrasonic cleaner. If the corrosion cannot be removed, the instrument should be discarded and may no longer be used.

- Encrustations must be thoroughly removed using nylon brushes
- Encrusted blood can also be dissolved using hydrogen peroxide 3%
- Instrument disinfectant residues can be removed by rinsing several times with water.

Cleaning/disinfection

For cleaning and disinfection **Dr. Ihde Dental** recommends the use of:

- Instrument disinfectant (reaction time with high bacterial loading 15 minutes in a 3% concentration) or drill disinfectant (reaction time with high bacterial loading 15 min.).

Ensure when using other products for cleaning and disinfection,

- that the products are basically suitable for the cleaning and disinfection of instruments
- that the cleaning and disinfection agent – if applicable – is suitable for ultrasonic cleaning (no foaming)
- that a cleaning and disinfection agent with proven efficacy (e.g. DGHM or FDA approved and CE Mark) is used

and that the chemicals used are compatible with the instruments: alkaline cleaning solutions should be preferred. A prerequisite for the use of a combined cleaning/disinfection agent is very low bacterial preloading (no visible contamination) due to effective pre-cleaning of the instruments. The concentrations and reaction times given by the manufacturer of the cleaning-disinfection agent must be strictly adhered to. Use only freshly mixed solutions, sterile or low-bacteria (max. 10 germs/ml) and low-endotoxin (max. 0.25 endotoxin units /ml) water (e.g. aqua vaide purificata) and only filtered air for drying. Instruments that cannot be autoclaved must be disinfected before each use.

Process: Cleaning and disinfection

Automatic cleaning in a cleaning and disinfection unit in combination with the cleaning agent recommended by the unit manufacturer.

Procedure: Insert the instruments so that the liquid can flow out of the drain tubes and blind holes. Set the cycle and adhere to the unit manufacturer's wash and rinse times. The cleaned components should be examined for visible dirt when removing the instruments. If necessary, repeat the cycle or clean manually.

Manual cleaning

1. Thoroughly clean disinfection/cleaning agent from the instruments by rinsing them with water and, if required, with the aid of a soft nylon brush. **Ultrasonic cleaner:** Place the components in a basket, avoid acoustic shadows. Add an enzymatic cleaning agent to the water and clean the components at a temperature of 40 - 50° C in the ultrasonic cleaner (35-40 kitz) for 3 minutes. Ensure that the components are immersed completely in the water without bubbles.
2. Then remove the instruments from the cleaning solution and rinse them thoroughly (minimum 1 min.) under running water. Use fully desalinated water for this stage, if possible.
3. Then dry the instruments with compressed air
4. Check the instruments visually and repeat the cleaning stage, if necessary.
5. Pack the instrument as soon as possible after removal (see Section "Packaging", if necessary after drying again at a clean location).
6. Document the approval.

Mechanical cleaning

Cleaning, disinfection and drying in accordance with DIN EN ISO 15883-1:2006 and DIN EN 15883-2:2006. **Pre-cleaning:** Place the disassembled instruments in cold water for 5 minutes. Then brush the disassembled instruments with a soft nylon brush under water to remove coarse impurities. **Mechanical cleaning:** e.g., using the Miele 8535 CD unit at 55° C for 5 minutes [programme Vario TD] with an enzymatic cleaner.

Important points

- All instruments must be sterilised after cleaning.
 - When sterilising multi-part instruments in an autoclave without a drying programme, it is essential that the instruments are always sterilised in a disassembled state!
 - The instruments should always be checked for corrosion after sterilisation.
 - The scaling of the instruments must still be visible after sterilisation; otherwise the instruments should be replaced.
 - New instruments must be cleaned and sterilised without packaging before using for the first time.
 - Preparation of all instruments with cavities is particularly critical. This applies especially to internally cooled drills, placement aids and instruments with blind holes. As the water supply cavity cannot be checked with internally cooled drills and bone chps and debris could be carried from patient to patient, we recommend using these instruments as single-use products only or using them exclusively on one patient. With all other instruments it must be ensured that the cavities are completely clean. Multi-part placement aids should be disassembled for cleaning, if possible.
- Control**
Check all instruments after cleaning and cleaning/disinfection for corrosion, damaged surfaces, chipping, damage to the shape (e.g. bent and non-concentric running instruments, damaged or blunt blades) as well as contamination and discard any damaged instruments. Instruments that are still contaminated must be cleaned and disinfected again. Then check the function and integrity of the instruments. It is not necessary to apply care products (e.g. oil) to instruments and abutments or screws.

Special aspects to observe with drills and cutters

Use cutting instruments for a maximum of 10 times. Thoroughly check the instruments after each use for cleanliness (including the internal cooling sections in particular) and the sharpness of the blades. The wear of bone drills depends on the hardness of the bone at the site. If in doubt, drills should only be used once. There is a considerable loss of cutting performance if the tip is damaged. To ensure care of the drills it is therefore essential to observe the following points:

- During the operation drills should be placed gently in the storage tray, which can be filled with physiological saline solution. Drills should not be kept in the physiological saline solution for longer than 1 hour to avoid corrosion.
- Never drop the drills directly on the tip.
- The drills should not come into contact during ultrasonic cleaning

Packaging

- Sort out the instruments in the sterilisation tray and then pack them in single-use sterilisation packaging (single or double packaging) and/or sterilisation container, which
 - complies with DIN EN 868-2/1/DIN EN ISO/ANSI AAMI ISO 11607
 - is suitable for steam sterilisation (temperature resistant up to min. 137° C [279° F], adequate steam permeability)
 - provides adequate protection of the instruments and sterilisation packaging against mechanical damage
 - is regularly serviced according to the manufacturer's instructions (sterilisation container)

Sterilisation

Method: Fractional pre-vacuum procedure (according to ISO 17665 or ISO 13040) in a unit that complies with EN 285
Temperature: Heat to 132° C, max. 137° C
Pressure: 3 pre-vacuum stages with min. 60 millibar pressure
Hold time: minimum 3 min. at 132° C
Drying time: minimum 10 min.

Check the sterile instrument packaging for damage after sterilisation, check the sterilisation indicators. To avoid staining and corrosion the steam must not contain any ingredients. The disinfectant therefore has to have been thoroughly removed. The recommended threshold limits of the ingredients for drinking water and steam condensate are specified in EN 285. Sterilisation using hot-air sterilizers and/or glass bead sterilizers is not advised, as the high temperatures blunt the cutting surfaces of the drills. Instruments should be sterilised in the trays recommended by the autoclave manufacturers if there is not a system-specific instrument tray available.

Storage

After sterilisation, the instruments must be stored dry and dust-free in the sterilisation packaging. The instruments should also be protected against sunlight and heat. The maximum storage period (expiry date) depends on several factors and must be determined and validated by the user.

Information on handling multi-part instruments

Multi-part instruments must be disassembled before sterilisation. Please note the schematic diagram below. **RAT2:** Unscrew the coverscrew and remove the push-rod. The push-rod and ratchet housing (inner and outer) must be thoroughly cleaned and then dried. The individual components of the ratchet are shrink-wrapped together in a sterilisation bag and sterilised. Ensure that the paper side of the sterilisation bag is placed so that the water vapour can escape and that the ratchet or its parts are not lying in water. After sterilisation, generally just before the beginning of implant placement, the ratchet should be thinly lubricated using a silicone oil and reassembled. The function of the ratchet should then be checked before beginning surgery.

Warnings

We do not know of any warnings, provided the instructions for use are followed for the products to be used as well as the corresponding disinfection and cleaning agent.

Dr. Ihde Dental AG reserves the right to change the design of the products and components or their packaging, adapt instructions for use as well as renege liability claims for defective products. Liability is limited to the use of defective products. Any further claims are excluded.

Further information about the preparation of medical products is available in the Internet at www.rki.de or www.a-k-i.org.

Date of the latest revision: 2017-11

Schematic diagram of the TW/TW2 torque wrench

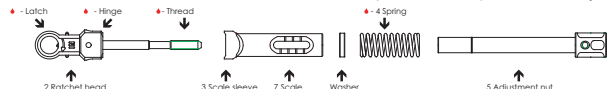
- After use the instrument should be disassembled into its individual parts – no tool is required for disassembly
- 

- Pre-clean the individual parts under running cold water using a soft brush. Do not allow blood residue and other adhering deposits to dry on the components.

Schematic diagram of the RAT2 ratchet

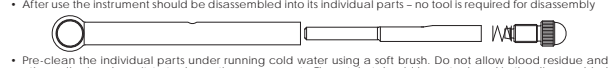
- After use the instrument should be disassembled into its individual parts – no tool is required for disassembly
- 

- Pre-clean the individual parts under running cold water using a soft brush. Do not allow blood residue and other adhering deposits to dry on the components. The ratchet should be autoclaved in the disassembled state and reassembled immediately before use.

Schematic diagram of the handle REF 311430 (can be disassembled)

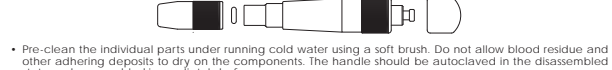
- After use the instrument should be disassembled into its individual parts – no tool is required for disassembly
- 

- Pre-clean the individual parts under running cold water using a soft brush. Do not allow blood residue and other adhering deposits to dry on the components. The handle should be autoclaved in the disassembled state and reassembled immediately before use.

Schematic diagram of the handle REF 311431 (cannot be disassembled)

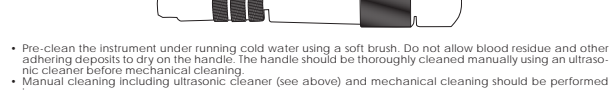
- Pre-clean the instrument under running cold water using a soft brush. Do not allow blood residue and other adhering deposits to dry on the handle. The handle should be thoroughly cleaned manually using an ultrasonic cleaner before mechanical cleaning.
 - Mechanical cleaning including ultrasonic cleaner (see above) and mechanical cleaning should be performed in sequence.
- 

Dr. Ihde Dental AG
 Dorfplatz 11
 CH-8737 Gommiswald
 Tel. +41 (0)55 292 23 23
 Fax +41 (0)55 290 23 00
 contact@implant.com
 www.implant.com

Distributed by
Dr. Ihde Dental GmbH
 Erfurter Str. 19
 D-85386 Eching
 Tel. +49 (0) 89 319 761 0
 info@ihde-dental.de
 www.ihde-dental.de

onewaybiomed GmbH
 Dorfplatz 11
 CH-8737 Gommiswald
 Tel. +41 (0)55 293 23 23
 contact@implant.com
 www.implant.com

ООО Ванвейбиомед
 BY 220123, Веларусь,
 г. Мінск
 ул. Кропоткина 84
 +375 29 997 99 99
 info@swissbiomed.ru

Legend	
	Read instructions
	Expiration date
	Gamma-sterilized
	Only use once
	Do not re-sterilize
	non sterile
	LOT Charge number
	Keep in a dry place
	Store tightly keep closed
	Do not use if packing is damaged
	Manufacturer

CE1936

IHDE DENTAL

(The products of this catalogue are CE marked (class I) and CE 1936 marked (class IIa and IIb) according to 93/42/EC Directive).

Commercial products that are not monitored by our notified body are declared as third-party products.

We are certified according to DIN EN ISO 13485 and Annex II of Directive 93/42 EEC.

The product dimensions shown in this brochure may differ from reality for technical reasons.

KOS® is a registered trademark. Pat. Pend.

If implants are reprocessed, there is a risk of the development of infections, because no validated method for processing exists.

Implants therefore may not be reprocessed.

Compilation and explanation of symbols on the packaging:



Batch No.



Sterilized by
gamma radiation



Non-sterile



Intended for use
by dentists or
surgeons only



Single use
product



Instruction
for use



Expiry date



Store
in a dry
place



Store tightly
keep closed



Do not use if
packing is
damaged



Do not
resterilize



Manufacturer



Production
date



Catalogue
number

COMPRESSION SCREWS

KOS®

KOS® MU



1st cortical

2nd cortical

COMBINATION IMPLANT

KOS® PLUS



IHDE DENTAL

Dr. Ihde Dental AG
Dorfplatz 11
CH - 8737 Gommiswald / SG
Tel +41 (0)55 293 23 23
contact@implant.com
www.implant.com

Dr. Ihde Dental GmbH
Erfurter Str. 19
D - 85386 Eching / Munich
Tel +49 (0)89 319 761 0
Fax +49 (0)89 319 761 33
info@ihde-dental.de
www.ihde-dental.de