

IHDE DENTAL 



SINGLE PART IMPLANTS **IMMEDIATE LOADING
DENTAL IMPLANT
SYSTEM**

KOS **ROOT[®]**

THE ADVANTAGES

OF THE ENDOSSEOUS DENTAL IMPLANT SYSTEM **ROOT®**

KOS **ROOT®** implants are used for crowns, bridges and bars. The compression screw design permits to incorporate the restoration in an immediate loading protocol (incorporation of the prosthesis within max. three days). The single-piece design reduces costs, the danger of periimplantitis and it eliminates the hazzles of screw loosening. KOS **ROOT®** implants are straight with prosthetic head for cementation.

The prescribed or recommended tightening torques for implants can be found on our website:

www.implant.com/en/downloads



Immediate loading protocol

Very few working steps

Compression thread

Made of highly resistant titanium alloy

Smart instrument tray





Wide range
of sizes

Enossal length 6 - 20 mm
Enossal Ø 3.0 - 5.5 mm

Angulation adapter
15° and 25°



No-Itis®
Laser Surface

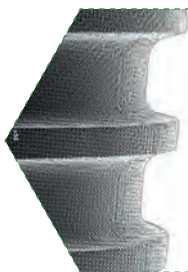

A smooth
surface that, in
contact with the bone,
is shaped like a
rough surface

The new surface treatment for Dr. Ihde Dental AG implants is created with the latest generation of robotic tools for laser ablation. This new technology of high precision creates roughness in the implant through a mesh of hemispherical micrometric pores, with a defined, always identical size and shape and with a symmetrical distribution. The result is a more adequate topography, which provides the most suitable conditions for the osseointegration of the implant, but at the same time it is, and behaves like, a smooth surface at a micrometric (cellular) level. This means that while bone grows well on this surface, the adhesion of bacteria to the same surface is significantly reduced.

KOS ROOT® IMPLANTS

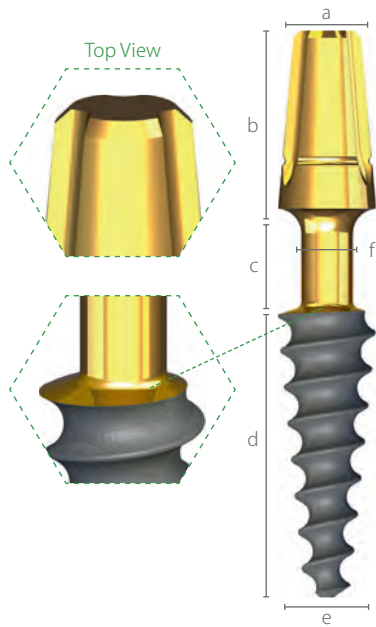

- a) Abutment Ø 3.9 mm
- b) Abutment height 7.2 mm
- c) Neck length 3.7 mm
- d) Enossal length 6 - 20 mm
- e) Enossal Ø 3.0 - 5.5 mm
- f) Neck Ø 2.0 - 2.55 mm
- KOS ROOT® 3.0 - 4.0 Max. insertion torque 50 Ncm
- KOS ROOT® 4.5 - 5.5 Max. insertion torque 80 Ncm

INCLUSIVE

KOS ROOT® implants are delivered incl. lab-set REF 462353, consisting of



Double analogue, plastic

IA4/IAU
462111



Impression and castable abutment, engages in the three vertical notches

PA X
462136



Impression post castable, internally round

TSPA 4
462029

NOTE TSPA 4 is part of the standard lab-set, but **CAN NOT** be used for KOS ROOT®. **TSPA 4** can only be used on implants with a small abutment head, which can be found in the extended Ihde Dental KOS® system application..



Neck Ø 2.0 mm:



Enossal Ø	Enossal length	Neck Ø	Note	REF	Price cat.
3.0 mm	6 mm	2 mm	bendable	458100	F
	8 mm			458101	
	10 mm			458102	
	12 mm			458103	
	14 mm			458104	
	16 mm			458105	
	18 mm			458106	
3.5 mm	20 mm	458107			
	6 mm	458110			
	8 mm	458111			
	10 mm	458112			
	12 mm	458113			
	14 mm	458114	F		
	16 mm	458115			
4.0 mm	18 mm	458116			
	20 mm	458117			
	6 mm	458120			
	8 mm	458121			
	10 mm	458122			
	12 mm	458123			
	14 mm	458124	F		
4.5 mm	16 mm	458125			
	18 mm	458126			
	20 mm	458127			
	6 mm	458130			
	8 mm	458131			
	10 mm	458132			
	12 mm	458133			
5.0 mm	14 mm	458134	F		
	16 mm	458135			
	18 mm	458136			
	20 mm	458137			
	6 mm	458140			
5.5 mm	8 mm	458141			
	10 mm	458142	F		
	12 mm	458143			
	14 mm	458144			
5.5 mm	6 mm	458150			
	8 mm	458151			
	10 mm	458152	F		
	12 mm	458153			
	14 mm	458154			

ADDITIONAL IMPRESSION TAKING AND LABORATORY ACCESSORIES



Description

Impression post
Internally round

Unit

Pack of 5

Material

POM

Code

TSPA 5

REF

462030

Price cat.

B

For impressions on ground-down implant heads. The ring transfer constitutes the lower limit of the head, so that the impression can be poured with die stone or epoxy. Material: PP



Double analogue

1 piece

Metal

IA4/IAU

462112

A



Castable abutment for large head
Internally round

Pack of 5

POB

462086

B

CEMENTABLE ANGULATION ADAPTER (Ti6AL4V)

These adapters are mounted on KOS **ROOT**® implants to compensate for the insertion direction. Plastic cements are preferably used. The implant head must be roughened beforehand. The protruding head parts are then removed. The impression is taken directly on the adapter.



Description

Adapter 15°

Code

AA5 15°

REF

462052

Price cat.

C



Adapter 25°

AA5 25°

462053

C



INSERTION TOOLS



Description

Length 23 mm
Use with contra-angle

Code

IT2W

REF

900039

Price cat.

E



Use with ratchet

IT2 BCS

900030

E



Torque wrench 10-70 Ncm

TW2

425402







S

HEATLESS® DRILLS

Surgical steel, colour-coded, depth-coded and autoclaveable. The drill is marked with laser depth markings. Use between 3,000 and 5,000 rpm with good cooling and intermittent drill technique. Due to the extremely high cutting performance, you can work without pressure.

-55%
heat



DRILLS MUST BE CHOSEN DEPENDING ON BONE QUALITY AND IMPLANT DIAMETER.

	Description	Colour	Max. working length	REF	Price cat.
	DOS 1	yellow	17 mm	455311	D
	DOS 2	black	17 mm	455312	D
	DOS 3	red	17 mm	455313	D
	DOS 4	blue	21 mm	455314	D
	DOS 5	green	17 mm	455315	D
	DOS 6	transparent	15 mm	455316	D

DOS 6 This drill is 2 mm shorter at the tip. It can therefore drill up to 2 mm deeper into hard bone than nominally indicated on the drill. Therefore, the conical bone cavity is only circularly extended in the crestal area without increasing the drilling depth.

PATHFINDER DRILLS

Conical 3-edge drill as initial drill, ideally suited for all crestal implant systems. The drill also passes between narrow cortical areas without pressure. **For implants up to 20 mm length.**

	Description	Colour	Max. working length	REF	Price cat.
	BCDX 1	yellow	15 mm	900243	C
	BCDX 2	black	15 mm	900244	C
	BCDX 3	red	15 mm	900245	C

| 47 mm |

STARTER TRAY

Autoclaveable up to 134° C, not suitable for dry heat sterilizers. This surgical kit contains all drills and tools for first works with the system KOS ROOT®. Material: autoclaveable plastic.



Description	REF	Price €
IT 2 BCS	900030	
IT 2 S BCS	900038	
DOS 1	455311	
DOS 2	455312	
DOS 3	455313	
DOS 4	455314	
DOS 5	455315	
BCDX 1	900243	
BCDX 2	900244	
BCDX 3	900245	
Torque wrench TW2	425402	
Starter tray with content	60060-K	upon request

SURGERY

KOS **ROOT**® implants are used as compression screws. If possible, the hole should be created substantially thinner than the core diameter of the implant, since only in this way can good bone condensation be achieved. The minimum hole diameter depends on the bone density. For this reason, it is not possible to specify drill sequences that can be used favorably for all bone qualities. As a rule, it is necessary to drill much less into the soft maxilla (e.g. the DOS1 drill only can be used for KOS **ROOT**® implants with diameter 3.0-5.0) than into the well-mineralized mandible, which requires the use of a drilling sequence adjusted to the bone density. **In very hard bone the implants should be inserted slightly deeper and then turned back 1/2 round.**

1. Handling

Hold the implant by the holder and place the insertion tool on the implant head. The endosseous implant surface must not be touched. Pull out the implant with the plug and then twist off the plug with the needle holder at the predetermined breaking point.

KOS **ROOT**® implant with insertion tool **IT2W** (for angle piece) and **IT2 BCS** (manual)

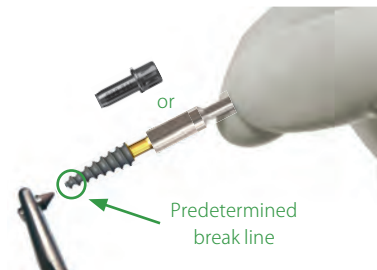

Twisting off the bracket with the needle holder

3. Impression

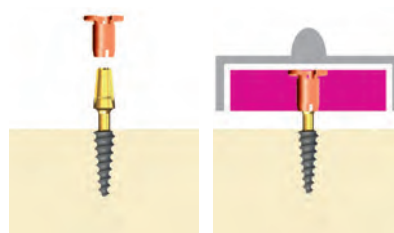

Attachment of the impression post

Pressureless impression taking

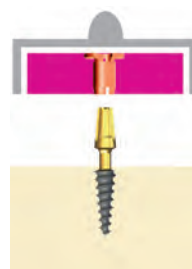

Removal of the scoop from the implant. The impression post is located in the impression material. The impression can be sent to the laboratory.

2. Insertion using manual tools

Insert the implant by hand until it is firmly seated in the jaw.



IT2 BCS

IT2W

Using the ratchet, torque ratchet or contra-angle, screw the implant clockwise into the cavity. The endosseous part of the implant must be completely covered by bone. The polished implant neck is located in the mucosa. We recommend screwing the implant into the bone up to 1 mm deeper into the implant neck.

4. Laboratory procedures

Attachment of the impression post onto lab analogue.

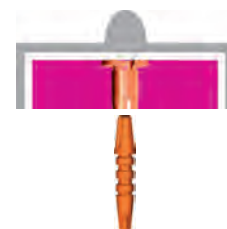

IA4/IAU

The modeling is performed on the castable part POB (internally round; for bridges and bars).

Basal implants may only be used and operated by qualified persons with valid authorisation (para. 2 MedProdAnw Verordnung). We are certified according to DIN EN ISO 13485 and Annex II of Directive 93/42 EEC. The product dimensions shown in this brochure may differ from reality for technical reasons. KOS® is a registered trademark. Pat. Pend. If implants are reprocessed, there is a risk of the development of infections, because no validated method for processing exists. Implants therefore may not be reprocessed.

COMPILATION AND EXPLANATION OF SYMBOLS ON THE PACKAGING:



Batch No.



Sterilized by gamma radiation



Non-sterile



Intended for use by dentists or surgeons only



Single use product



Instruction for use



Expiry date



Store in a dry place



Store tightly keep closed



Do not use if packing is damaged



Do not resterilize



Manufacturer



Production date



Catalogue number

(The products of this catalogue are CE marked (class I) and CE 1936 marked (class IIa and IIb) according to 93/42/EC Directive).

Commercial products that are not monitored by our notified body are declared as third-party products.

IHDEDENTAL 

Dr. Ihde Dental AG
Dorfplatz 11
CH - 8737 Gommiswald / SG
Tel +41 (0)55 293 23 23
contact@implant.com
www.implant.com

Dr. Ihde Dental GmbH
Erfurter Str. 19
D - 85386 Eching / Munich
Tel +49 (0)89 319 761 0
Fax +49 (0)89 319 761 33
info@ihde-dental.de
www.ihde-dental.de