

**IHDE**DENTAL 

TWO PIECE IMPLANTS  
DENTAL IMPLANT  
SYSTEM  
**HEXACONE®**

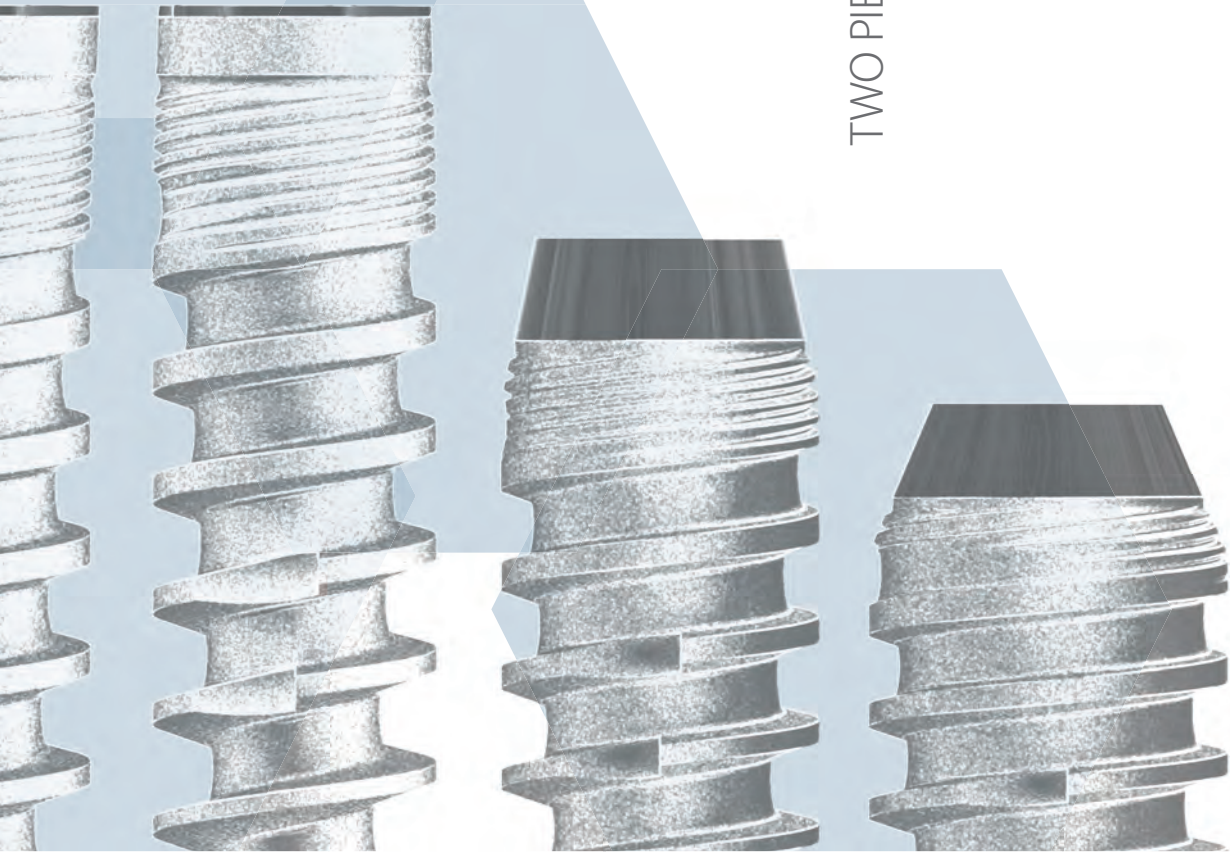

“FOR ME, IMPLANTOLOGY BEGINS  
WHERE OTHERS HAVE GIVEN UP.”

- Dr. Stefan Ihde



Dr. Ihde Dental has been a reliable partner for over 60 years providing a wide range of implant systems and consumables. We supply dentists and dental technicians with precisely coordinated materials and systems, which are easy and reliable to use. We always ensure high quality and an excellent price-performance ratio so that you can guarantee allround treatment for your patients that is cost-effective and highly efficient. The following catalog gives you an overview and all the essential information about our implant systems. You can also contact us personally any time using the phone numbers provided. Further information can be found on our websites:

[www.ihde.com](http://www.ihde.com) || [www.ihde-dental.de](http://www.ihde-dental.de) || [www.ihde.com](http://www.ihde.com)

**The company** was founded in 1954 in Berlin by the dental technician Klaus Ihde. The company relocated to Bavaria in the 1960s. At the end of the 1980s, Dr. Ihde Dental GmbH (Germany) and Dr. Ihde Dental AG (Switzerland) were formed from the Klaus Ihde retail company. Ihde Dental is now represented in four locations in Europe and over 45 countries. The company group is one of the most innovative implant companies in the world – based on new developments and patents issued or pending.

**The core activities** of Ihde Dental are the development, procurement and distribution of medical products. We use a large number of suppliers in consumables, but we have produced implants in our own factory for many years. All components are manufactured quickly, precisely and economically thanks to state-of-the-art production technology and well-equipped machinery.

#### **Our partners**

Users and customers provide us with many new ideas and excellent suggestions. Collaboration with our customers is extremely important to us. Contact us at any time if you have any improvements or questions. Your ideas and opinions help us all to meet the daily wishes of patients to a greater and better extent. We also put the needs of the patient first..

#### **Our market performance and work ethic**

Since it was founded, the company has focused on innovative ideas and advanced technology, premium quality, an excellent price-performance ratio, optimal patient and user friendly products and durability. Our range combines the latest findings from research and practices in many countries around the world.

Customer orientated to us means – **available for you!**

- We provide training courses, refresher courses and user advice.
- We provide customers with comprehensive and technically sound advice.
- We also visit you in your practice upon request.

**Please call us to arrange an appointment  
or send us an email.**

**IHDE**DENTAL 

**Dr. Ihde Dental AG**  
Dorfplatz 11  
CH - 8737 Gommiswald / SG  
Tel. +41 (0)55 293 23 23  
contact@implant.com

**Dr. Ihde Dental GmbH**  
Erfurter Str. 19  
D - 85386 Eching / Munich  
Tel. +49 (0)89 319 761-0  
Fax +49 (0)89 319 761-33  
info@ihde-dental.de

# THE ADVANTAGES

OF THE ENDOSSEOUS DENTAL IMPLANT SYSTEM **HC2**

**HC2** implants with aggressive apical thread have a roughened endosseous surface. They feature an internal hex, an internal marginal taper and a US standard internal thread. As a result of many years of clinical observation of products, Dr. Ihde Dental AG has revised the design of the famous **Hexacone**<sup>®</sup> implants: The broadened apical thread is fully self-cutting. Thanks to the new apical thread portion, the implant is more stable even in weak bone and higher insertion torque can be reached.

The prescribed or recommended tightening torques for implants, abutments and screws can be found on our website:

[www.implant.com/en/downloads](http://www.implant.com/en/downloads)



Clean and secure interface due to hex and conus

Can be anchored bicortical

Safe rotation protection through precision internal hexagon

Made of highly resistant titanium alloy

Smart instrument tray

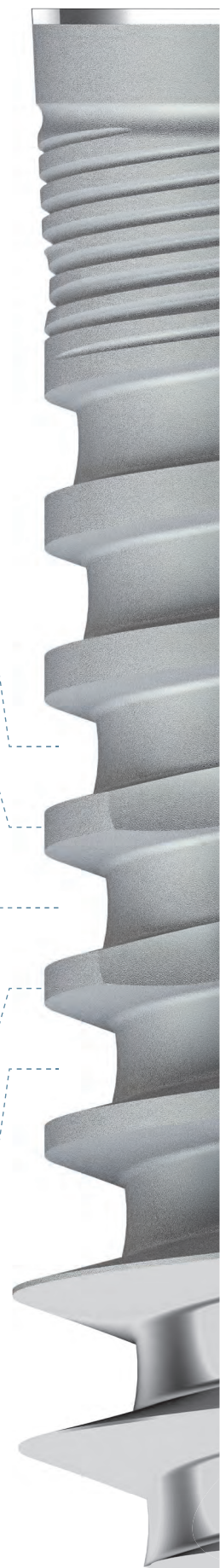

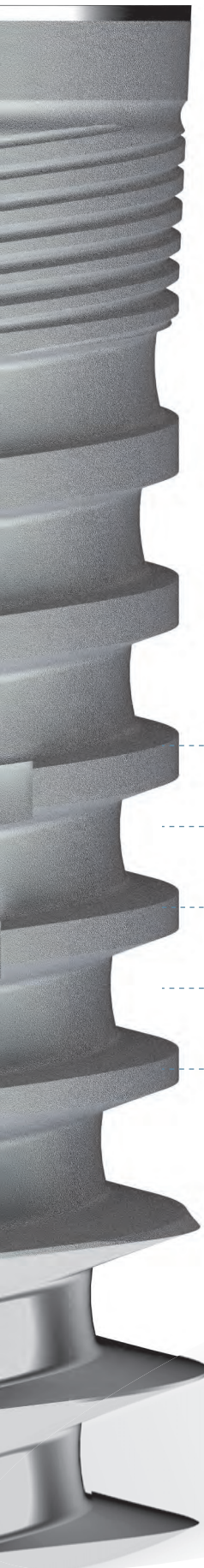

Wide range  
of sizes

Enossal length	8 - 15 mm
Enossal Ø	3.3 - 5.5 mm

**No-Itis®  
LASER:**

The new surface treatment for Dr. Ihde Dental AG implants is created with the latest generation of robotic tools for laser ablation. This new technology of high precision creates roughness in the implant through a mesh of hemispherical micrometric pores, with a defined, always identical size and shape and with a symmetrical distribution. The result is a more adequate topography, which provides the most suitable conditions for the osseointegration of the implant, but at the same time it is, and behaves like, a smooth surface at a micrometric (cellular) level. This means that while bone grows well on this surface, the adhesion of bacteria to the same surface is significantly reduced.

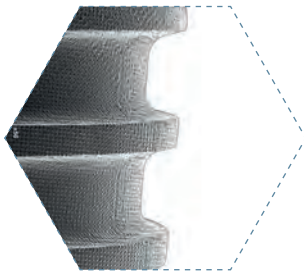

A smooth  
surface that, in  
contact with the bone,  
is shaped like a  
rough surface

Polished area for a  
clean closing-off

## No-Itis® LASER – THE NEW SURFACE GENERATION

The new surface treatment for Dr. Ihde Dental AG implants is created with the latest generation of robotic tools for laser ablation. This new technology of high precision creates roughness in the implant through a mesh of hemispherical micrometric pores, with a defined, always identical size and shape and with a symmetrical distribution.

The result is a more adequate topography, which provides the most suitable conditions for the osseointegration of the implant, but at the same time it is, and behaves like, a smooth surface at a micrometric (cellular) level. This means that while bone grows well on this surface, the adhesion of bacteria to the same surface is significantly reduced.

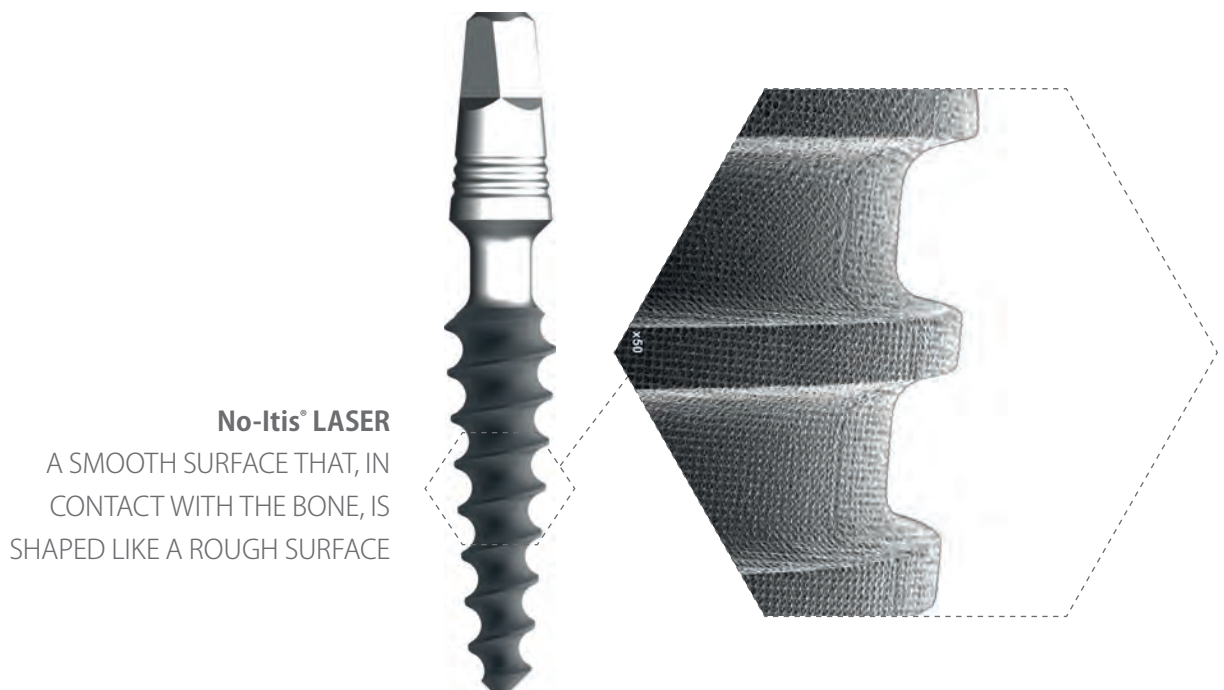

In the 1990s, rough surfaces on dental implants became increasingly popular – while the risk of bacterial adhesion was blissfully disregarded. This caused the appearance of a new disease, peri-implantitis, which severely compromises the survival of the implants in the long term and which, as a result, requires a renewed intervention on a dissatisfied patient, wasting time and increasing costs. Surfaces like that are not patient-friendly!

The use of the laser technology we developed allows us to create an exactly defined micromorphology on the treated surface, leaving no residue and without altering the properties or composition of the titanium alloy. This creates a mesh of very perfect cavities in terms of the (hemispherical) shape and its dimensions (of 20 to 30  $\mu\text{m}$ ), as well as their distance and distribution. The surface of these cavities as well as the retentions created by laser ablation are smooth as experienced by the bacteria, a characteristic that is assumed to improve the resistance of the implant against bacterial colonisation. This characteristic might also radically limit the incidence of peri-implantitis. In contact with the bone, however, the laser-ablated surface behaves like a rough surface. Rough implants (e.g., KOS®, Hexacone®) and smooth implants (e.g., BCS®, KOS®) therefore have the same recovery rate.

**No-Itis® LASER**  
THE SURFACE THAT INCREASES  
SURVIVAL RATIOS

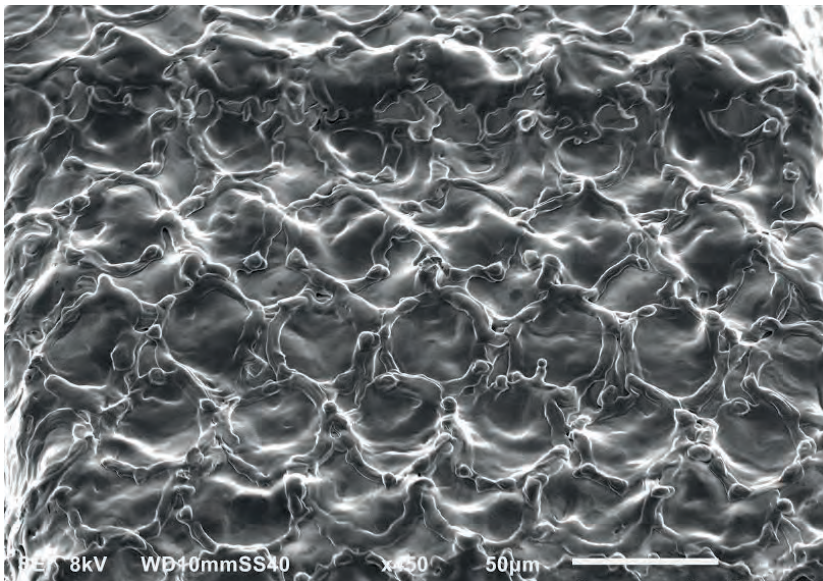

Rugosity (Ra)	Definition
≤ 0,4 µm	Smooth
0,5 - 1,0 µm	Machined
1,0 - 2,0 µm	Moderately rough
> 2,0 µm	Rough

Rugosity (Ra)	No-Itis® Laser
0,9 µm	Smooth

According to the classification of surface roughness by Albrektsson and Wenneberg, the Ra value corresponds to a smooth surface, and our lasered surface actually has the characteristics and many of the advantages of a smooth implant surface. The NO-ITIS® LASER surface allows the adhesion of the uniform and extended fibrin clot, which then leads to the formation of woven bone. The distribution and size of the concavities favours the accommodation and activity of the osteoblasts, promoting effective osseointegration

**No-Itis® LASER**  
 THE MOST ADVANCED SURFACE A SAFE ANSWER  
 AGAINST PERI-IMPLANTITIS, MAINTAINING THE  
 OSSEOINTEGRATION LONG TERM

**STABLE FIBRIN MESH**

With the NO-ITIS® LASER, as with traditional rough surface, fibrin filaments are almost exclusively attached to surface peaks forming bridges between them (distant osteogenesis). On the NO-ITIS® LASER surface, fibrin forms as a well developed and defined grid mesh even within the concavities, which favours colonisation of the osteogenic cells directly on the surface of the implant (contact osteogenesis).

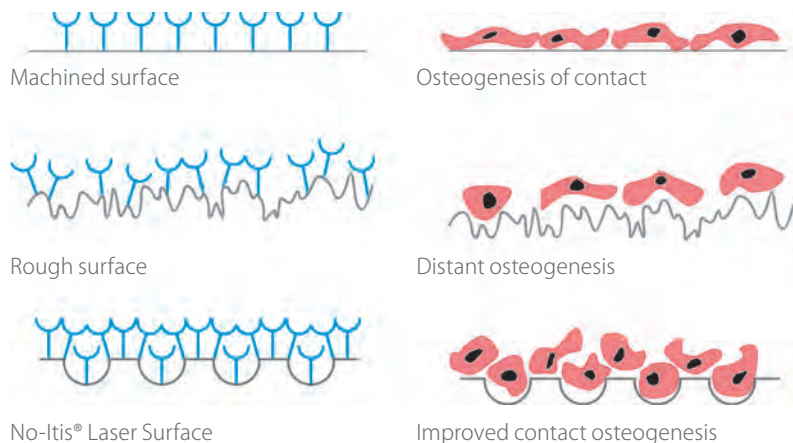

### MAXIMUM CONTACT OSTEOGENESIS

Thanks to the good cell adhesion, a normal fibrin mesh can be created, adapted and extended on the surface of the NO-ITIS® LASER. This process activates the formation of osteonal bone, also directly in contact with the implant.

**No-Itis® LASER**  
A UNIQUE SURFACE

### No-Itis® LASER

THE IDEAL SURFACE FOR IMMEDIATE  
OR EARLY LOADING

The perfectly symmetrical and reproducible topography of the NO-ITIS® LASER surface attracts a greater number of osteogenic cells, allowing them to settle and to proliferate on the implant surface in a stable and uniform manner. This process activates the formation of bone directly in contact with the implant, resulting in a more dynamic and favourable osseointegration, with greater BIC (Bone implant Contact), and it allows true bone engineering.

- Smooth implant surface
- Less bacterial adhesion

➔ LOWER RISK OF INFECTIONS

- Increased fibrin adhesion
- More contact osteogenesis on a larger surface

➔ PERFECT OSSEOINTEGRATION

### RAPID OSSEOINTEGRATION

The perfectly symmetrical and reproducible topography of the NO-ITIS® LASER surface attracts a greater number of osteogenic cells, allowing them to settle and to proliferate on the implant

### No-Itis® LASER – A CLEAN SURFACE

Unlike standard-surface implants (sandblasting and etching, or blasting and anodising), the implants with the NO-ITIS® LASER surface have a completely clean surface without residues nor contaminants. Due to this modern manufacturing process, no residues of jet particles or traces of the chemicals (acids) or anodisation (oxides) used in the etching process can come into contact with the implant. Eliminating the anodisation also eliminates the risk that the top layer of the coloured implant dissolves mechanically.

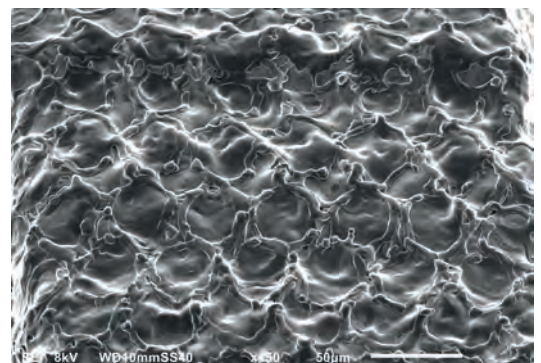

### No-Itis® LASER

A CLEAN SURFACE

### No-Itis® LASER – THE IDEAL SURFACE FOR BONE CONTACT

The total cleanliness of the NO-ITIS® LASER allows the endosseous implant surface to be increased without having to accept the disadvantages of all the traditional methods for surface roughening.

**This new surface generation can coexist for some time with others developed by Ihde Dental AG, while regularization of production and stocks, and therefore any reference may not be available on the new No-Itis® Laser surface.**



## PREPARATORY WORK FOR TEMPLATE APPLICATION

1. Ask your laboratory to prepare a drill template with the determined drillholes for the pilot drills. To be on the safe side, you can ask the laboratory to insert guide sleeves (**REF** BFH) into the drillholes, which specify the exact drill direction. Please use a 2.0 / 2.2 mm Ø drill for the pilot drilling.
2. For the following drill sequences you can use drill stops, which can be attached and tightened to the drill according to the length of drilling channel. Gingival thickness and template height are taken into account as needed. Thanks to the extremely high cutting efficiency of our drills, no ascending drilling sequences will usually be required.

Recommended RPM: 2000-5000. Apply sufficient cooling and allow the cooling to reach the working blades of the drills.

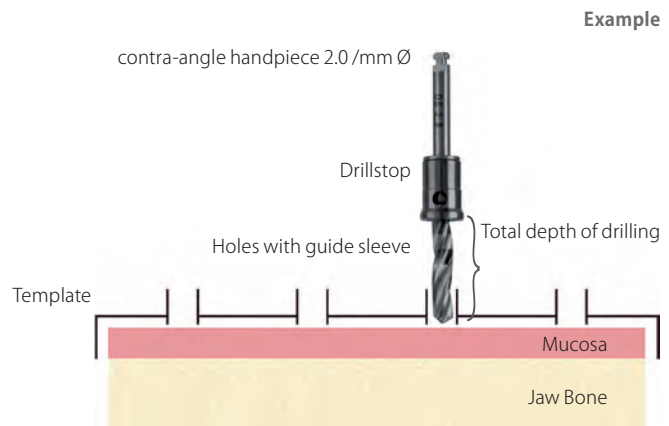

**General note:** Hexacone® implants are used as compression screws. In order to achieve a good bone condensation and implant stability, the drilling should be carried out thinner than the core diameter of the implant. The minimal diameter of the drill depends on the bone density. It is therefore not possible to advise drill-sequences which fit all bone-qualities. Typically in the soft maxillary bone only small drill-diameters are used (e.g. the usage of **DOS1** only, for Hexacone® implants with 3.3 - 5.5 mm diameter), whereas in the highly mineralized lower jaw a specific drill sequence with respect to the mineralization of the bone is necessary. For insertion under pressure use the Handgrip. Due to technical reasons Hexacone® 2.9 mmd is not available with expanded apical thread. **HC2** implants with diameters 2.9 and 3.3 mm as well as 3.7 mm are not for use as single tooth restoration.

**SURGERY**

**1. Recommended drill sequence**

HC 2.9  
(Head diameter 3.2 mm)



Step drill



or



The use of DFN is done without previous pilot drill.  
Max. torque during insertion of HC 2.9: 35 Ncm.



Bone

HC2 3.3



DFN 2.9 13

DFN 2.9 15

(hard bone: DFN 3.4/DFLN 3.4)  
Max. torque during insertion of HC 3.3: 40 Ncm.

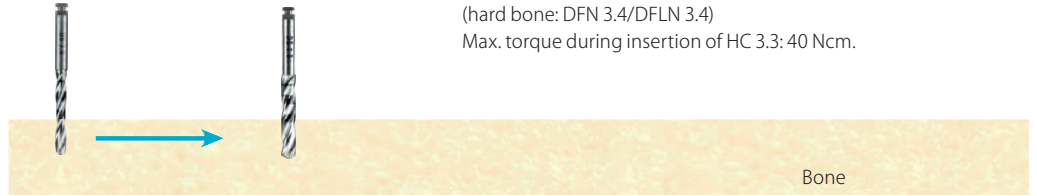

Bone

HC2 3.7



DS 2  
Pilot drill

DS 2.8  
Pilot drill

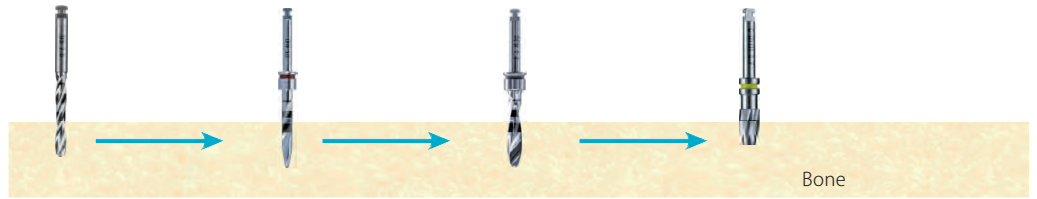

Bone

HC2 4.5 mm  
HC2 4.5 mm 6+2



DS 2  
Pilot drill

DFN 3.0

(DFN 3.4)

(C-Drill 3.7)  
(Corticalis drill)



Bone

HC2 5.5 mm  
HC2 5.5 mm 6+2



DS 2  
Pilot drill

(DFN 3.4) /  
DFN 3.7

DFN 4.2 - 4.5

(C-Drill 4.2 - 4.5)  
(Corticalis drill)

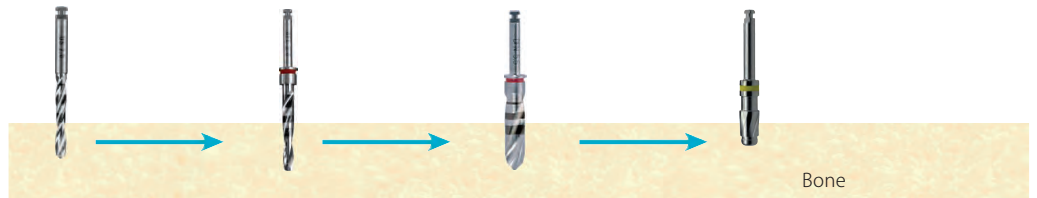

Bone

DS 2  
Pilot drill

DFN 3.7

DFN 5.5

(CSBL 4.8)

## 2. Implant packaging



Original packaging



Open the blister using the flap. Remove the label and stick it into the patients record.

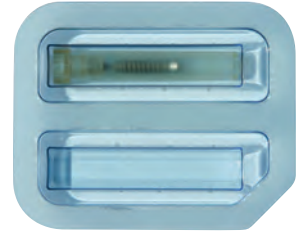

The blister (secondary packaging) contains the implant in a sterile tube (primary package).

## 3. Remove the implant from its packaging

1. Open the lid.
2. The implant is fixed to the lid by a break joint.
3. Remove the implant without touching the inner wall of the tube.

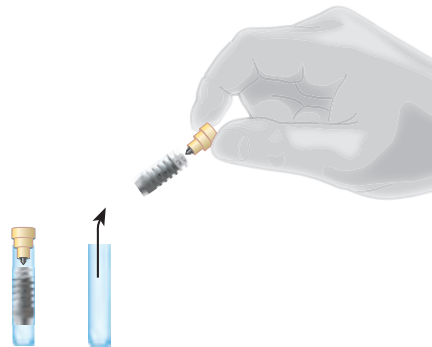

## 4. Handling

Attach the insertion tool to the implant by holding the top, to which the implant is secured, with your other hand.  
 Alternative: Firmly attach the assembled contra-angle hand-piece instrument IT 2.5 M to the implant. For ratchets ITL 2.5 can be used as well.

After you have attached the insertion tool, firmly hold the lid in your hand and break the implant off the top along the break joint. Then insert the implant into the drill hole as much as possible.

Insertion tool  
**IT 1 or IT 2**  
 Make sure the hexagon is in the correct position and that the tool is fully inserted.  
 Hexacone® Implant  
 Break joint  
 Lid with implant mount

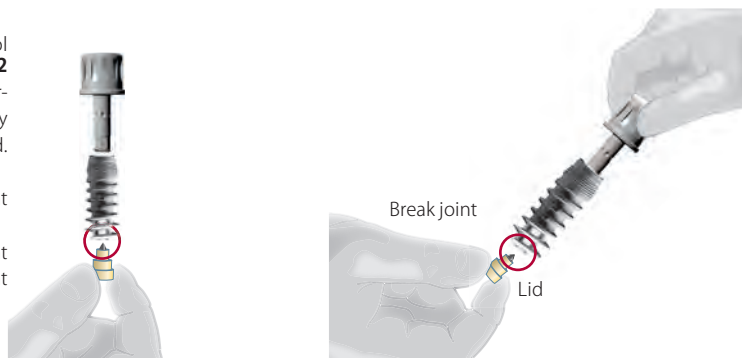

## 5. Insertion

Using the ratchet screw the implant clockwise into the cavity.

The endosseous part of the implant must be **completely** covered by the bone.

After insertion the implant can be turned by a ¼ rotation backwards in order to relieve the bone and allow blood access to the implant site.

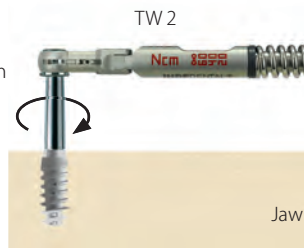

## 6. Remove insertion tool from implant

Remove the insertion tool from the implant.

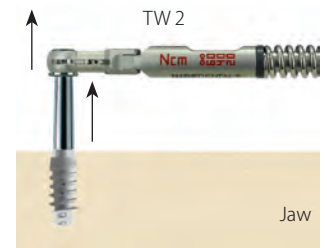

## 7. Result

Result: A correctly inserted implant

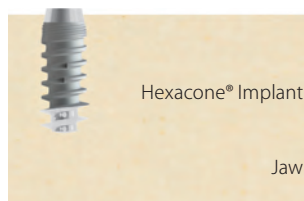

## 8. Post-operative treatment

Close the implant with the suitable surgical cover screw.

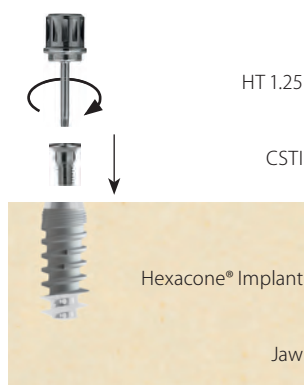

After healing:  
Remove the surgical cover screw.

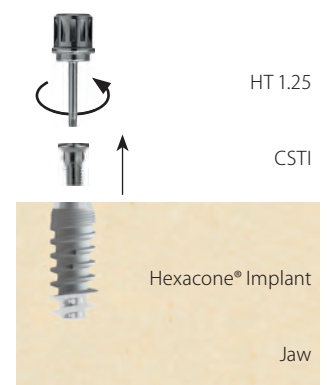

9. Handgrip

Use of Handgrip and Hexacone® adapter.



Break off the holder.

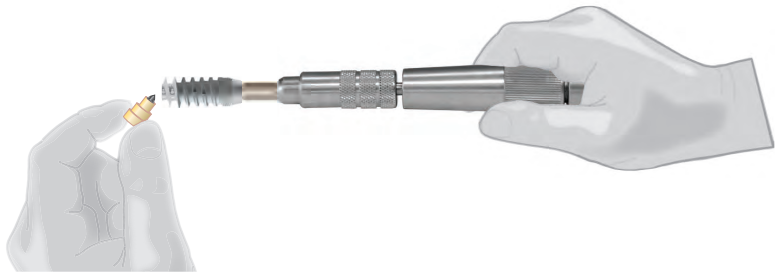

Insert the implant with axial pressure while turning.

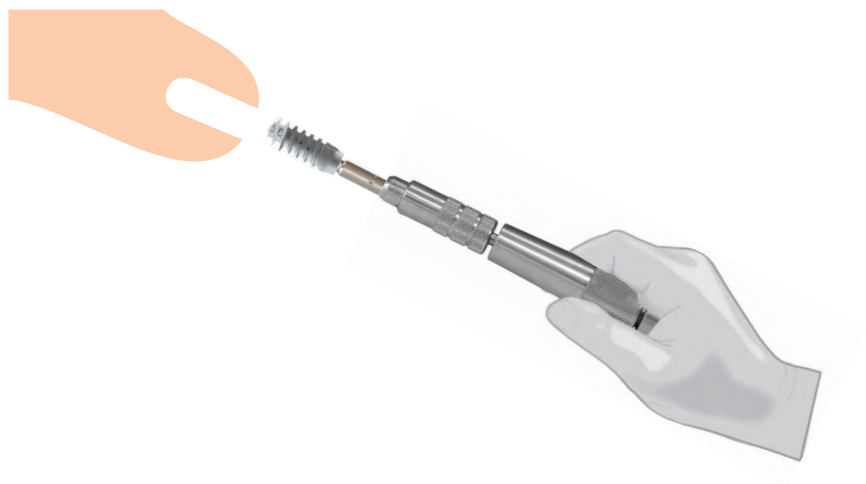

**Max. insertion torque for diameter**

2.9 mm	30 Ncm
3.3 mm	40 Ncm
3.7 mm	50 Ncm
4.5/5.5 mm	60 Ncm

### 10. Pick Up Impressions

Impression taking with an A-silicone such as Safeprint® by Dr. Ihde Dental. The use of open and closed impression tray is possible.

#### 10.1 Pick-up-procedure with an individual impression tray.



#### 10.2 Prior to the impression

For pick up impressions the tray is inserted over the impression post until the screw peaks out on the other side and becomes accessible for the HEX-tool.

The impression post HLT must not necessarily be unscrewed from the implant in order to remove the impression tray. It can be repositioned later as well

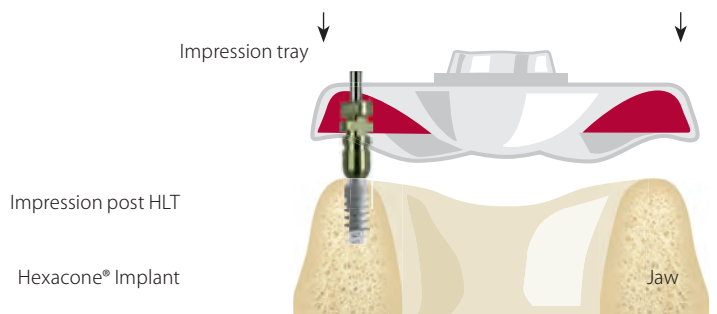

#### 10.3 Taking the impression

Disengage HLT from the implant: HLT remains in the impression

After the impression is taken, the implant is closed with a healing abutment (Gingiva former - straight or anatomic) and the impression is sent to the laboratory.

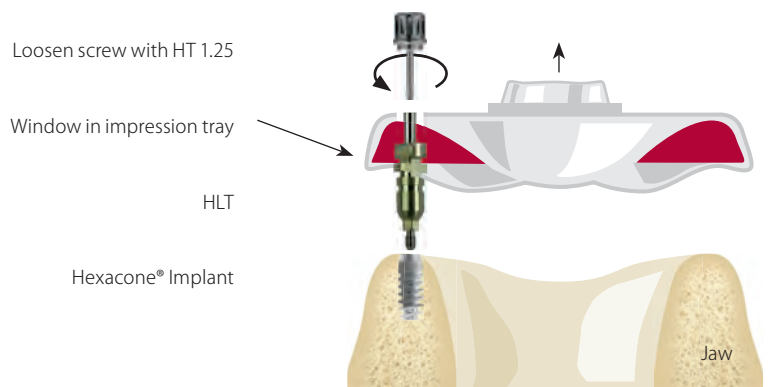

#### 10.4 Preparation of the impression tray for model fabrication

Screw analog against the impression post.

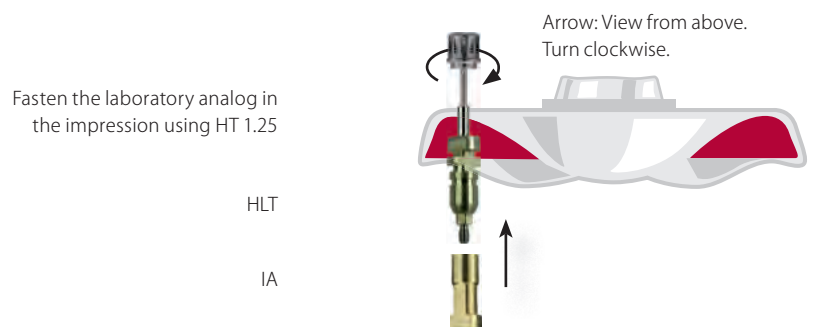

## 11. Closed tray impressions

### 11.1 Impression taking with a closed impression tray

To take impression use an adequately large impression tray.

Impression posts TS/TSL are mounted with the help of the knurled screw

Tighten the impression post with the knurled screw

TS/TSL HC

Hexacone® Implant

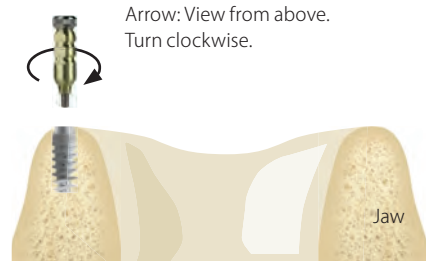

### 11.2 Inserting impression

The filled impression tray is positioned sufficiently deep over the impression post to also allow an impression of the mucosa.

Impression post TS/TSL HC

Hexacone® Implant

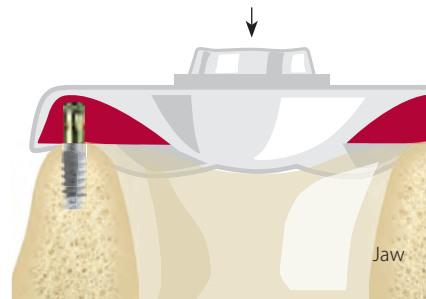

### 11.3 Removing impression

When the closed-tray method is applied, the impression post TS/TSL HC remains on the implant after the impression tray is removed. After removal of the impression tray the impression post will be unscrewed and repositioned in the impression.

After the impression is taken, the implant is closed with a healing abutment (Gingiva former - straight or anatomic) and the impression is sent to the laboratory.

TS/TSL HC

Hexacone® Implant

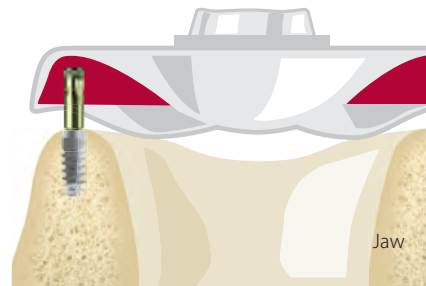

### 11.4 Mounting the lab analog

Screw analog IA or IA HC M to the transfer post TS HC. **A**

Afterwards the impression post is repositioned in the impression. **B**

The impression can now be casted. In IA HC M block the lower access to the lock screw out prior to casting.

Tighten the impression post onto the laboratory analog using the knurled screw

TS HC

IA or IA HC M

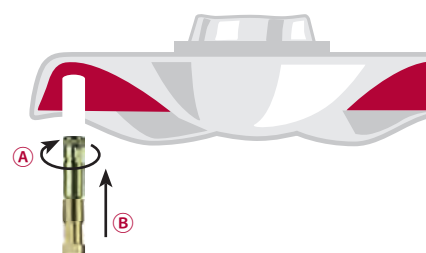

12. Laboratory procedures

12.1

The impression is poured. Then the impression posts (HLT or TS/TSL HC) are unscrewed from the laboratory analog.

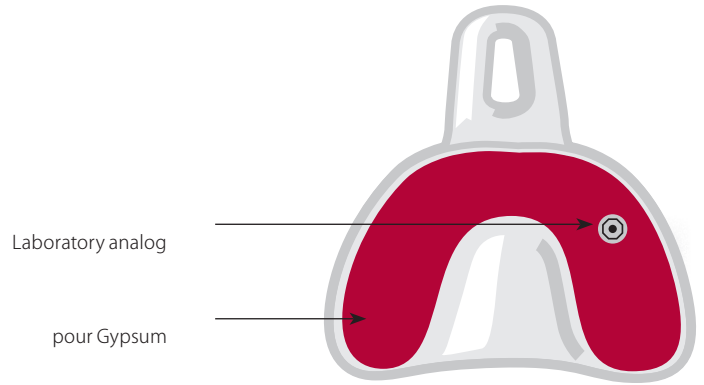

12.2

The laboratory analog is now in the proper position and orientation in the Gypsum.

IA or IA HC M



12.3

Positioning of the screwable abutments TLA15 HC, thereby the optimal position and adequate angulation must be determined.

HT 1.25

Insert screw

TLA 15

Take care to position the hexagon correctly



Arrow: View from above. Turn clockwise.

**NOTE** The hexagon must be completely inserted into the analog.

IA or IA HC M



12.4

Ensure proper position of the abutment when transferring into the mouth.

TLA 15 HC

Tightening torque of the screw during fastening on the implant: 20 Ncm



12.5

If more than one angled abutment is used, your laboratory will prepare a detachable synthetic bar (e.g. from Pattern Resin) in order to facilitate the correct positioning in the mouth.

TLA 15 HC

Pattern Resin®

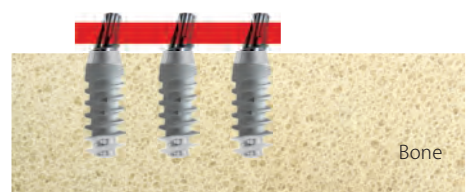



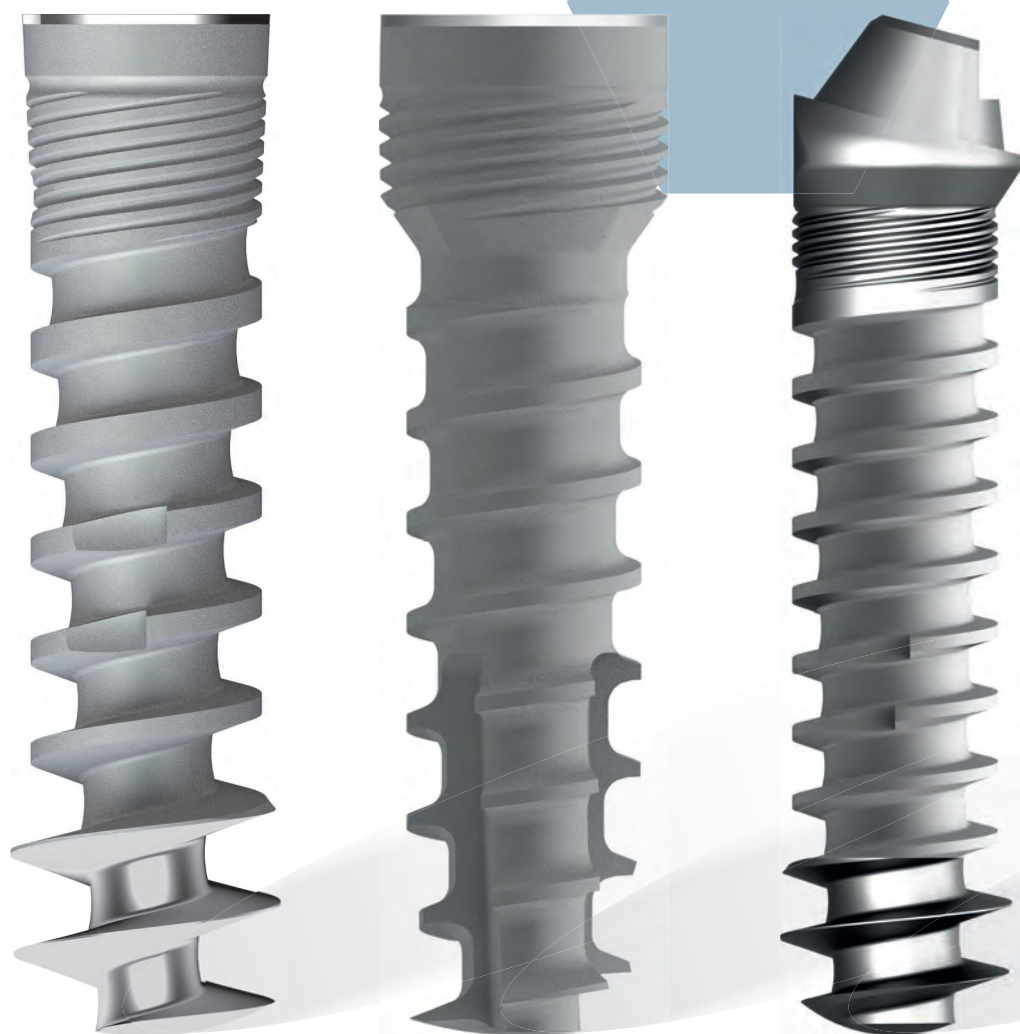

**TWO PART**  
DENTAL IMPLANT SYSTEM **HEXACONE®**

## HC2 IMPLANTS WITH AGGRESSIVE APICAL THREAD

HC2 implants have a roughened endosseous surface and a machined apical thread. They feature an internal hex, an internal marginal taper and a US standard internal thread.

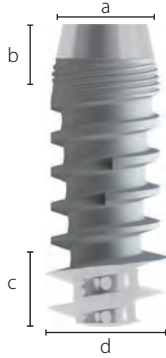

### Dimensionen HC2 4.5 13

a) Nominal Ø	4.5 mm
b) Length micro thread	2.5 mm
c) Height of apical thread	3.2 mm
d) Basal thread Ø	5.15 mm

### HEXACONE® WITH AGGRESSIVE APICAL THREAD: HC2

As a result of many years of clinical observation of products, Dr. Ihde Dental AG has revised the design of the famous Hexacone® implant: the broadened apical thread is fully self-cutting. Thanks to the new apical thread portion, the implant is more stable even in weak bone and higher insertion torque can be reached.

If the implant is anchored in the 2<sup>nd</sup> cortical, it may be used in immediate load protocols. Especially in the upper jaw the usage of the new handgrip (REF 311431, with Adapter IT HC REF 418196) for inserting the implant is mandatory. This tool allows to apply vertical insertion forces and will enhance the anchorage. The drill sequence remains unchanged compared to the former design of the Hexacone® implant. And of course all abutments and tools remain the same.

Should the first cortical be unusually firm, the insertion can be achieved using the handgrip REF311431 with the adapter IT HC REF418196.

### Application limitations

Hexacone® 2.9 mm implants may not be placed in a loaded area, especially not in the molar or premolar area. Likewise these implants may not be used where diagonal loading (off-axis loading) occurs, i.e. not for upper anteriors. Under no circumstances may Hexacone® 2.9 mm implants be used for work that involves unsupported occlusal surfaces (consoles). If used in immediate load protocols, the prosthetic construction must be safely inserted on the 2<sup>nd</sup> postoperative day, and it should not be removed within the first 6 months.

In general we recommend to use implants up to (and including) the diameter 3.7 mm with care and avoid using them for single tooth replacements, unless strict force control is guaranteed.

**HC2 IMPLANTS  
WITH AGGRESSIVE  
APICAL THREAD**



Description	Enossal Ø	Enossal length	REF	Price cat.
HC2 3.3 8	3.3 mm	8 mm	412220	G
HC2 3.3 10	3.3 mm	10 mm	412221	G
HC2 3.3 11.5	3.3 mm	11.5 mm	412222	G
HC2 3.3 13	3.3 mm	13 mm	412223	G
HC2 3.3 15	3.3 mm	15 mm	412224	G
HC2 3.7 8	3.7 mm	8 mm	412202	G
HC2 3.7 10	3.7 mm	10 mm	412203	G
HC2 3.7 11.5	3.7 mm	11.5 mm	412210	G
HC2 3.7 13	3.7 mm	13 mm	412204	G
HC2 3.7 15	3.7 mm	15 mm	412205	G
HC2 4.5 8	4.5 mm	8 mm	412206	G
HC2 4.5 10	4.5 mm	10 mm	412207	G
HC2 4.5 11.5	4.5 mm	11.5 mm	412208	G
HC2 4.5 13	4.5 mm	13 mm	412209	G
HC2 5.5 8	5.5 mm	8 mm	412211	G
HC2 5.5 10	5.5 mm	10 mm	412212	G
HC2 5.5 11.5	5.5 mm	11.5 mm	412213	G
HC2 5.5 13	5.5 mm	13 mm	412214	G



Delivery inclusive surgical screw CSTI, REF 418101

## HEXACONE® 6+2 IMPLANTS WITH AGGRESSIVE APICAL THREAD

**Hexacone® 6+2** was especially developed for the area of the 1<sup>st</sup> and 2<sup>nd</sup> molars in the upper and lower jaw. It is possible and recommendable to use it as a compression screw implant in the upper jaw. Endosseous length 6-8 mm (8 mm incl. reverse cone). The upper edge of the polished 75° reverse cone can end at bone level or slightly above it. **Hexacone® 6+2** implants have a laser-generated surface structure (No-Itis® laser) in the enossal area.

The conical polished implant head (a) should be submerged into the bone.

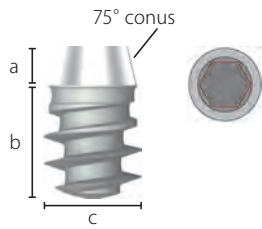

- a) Reverse conus            2 mm
- b) Enossal length            6 mm
- c) Enossal Ø                4.5 - 5.5 mm

### Description

HC2 4.5 6+2  
HC2 5.5 6+2

### Enossal Ø

4.5 mm  
5.5 mm

### Enossal length

6 mm  
6 mm

### REF

412217  
412218

### Price cat.

G  
G

Delivery inclusive surgical screw CSTI, REF 418101

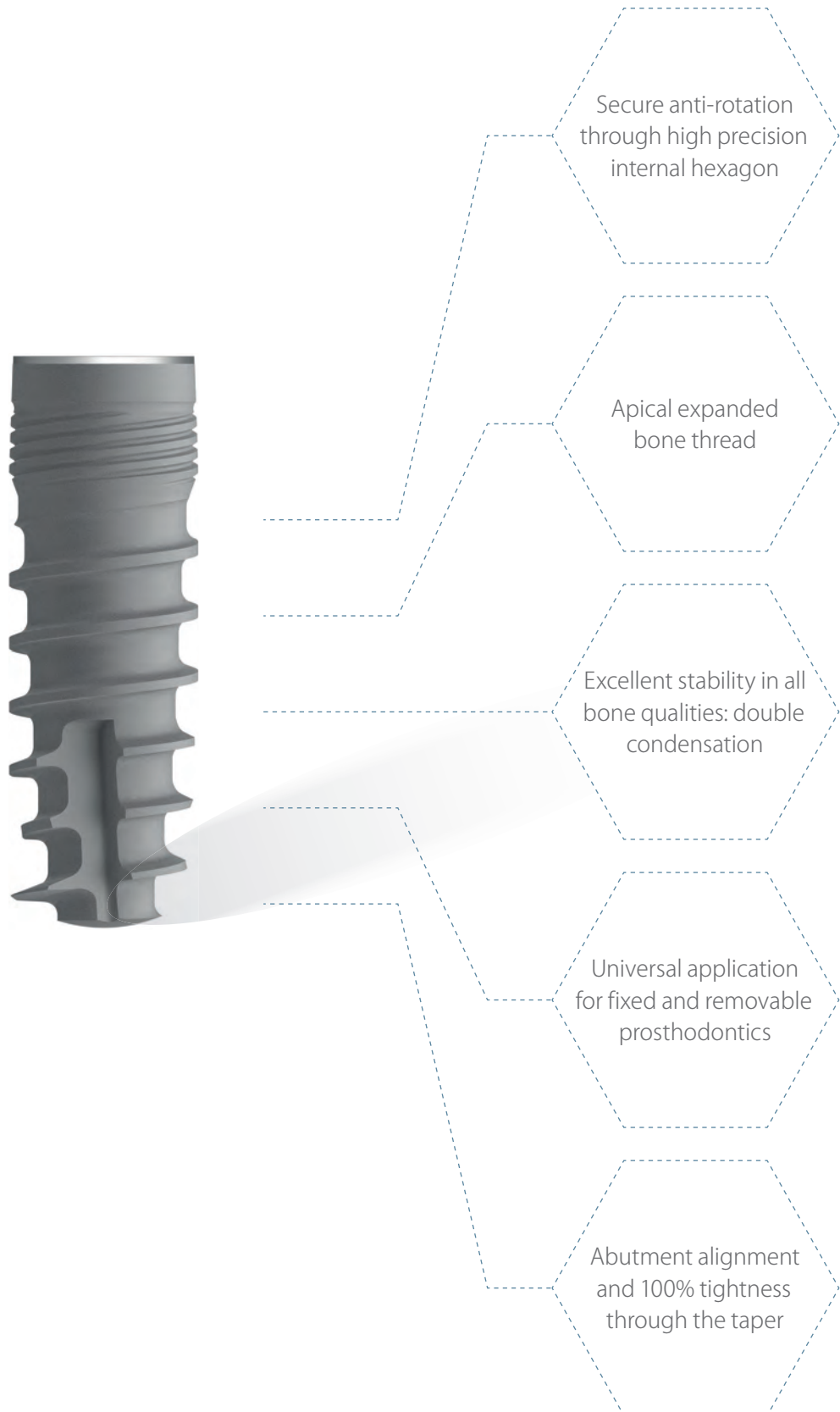

**THE ADVANTAGES** OF TRADITIONAL **HEXACONE®** IMPLANTS

TRADITIONAL HEXACONE® IMPLANTS

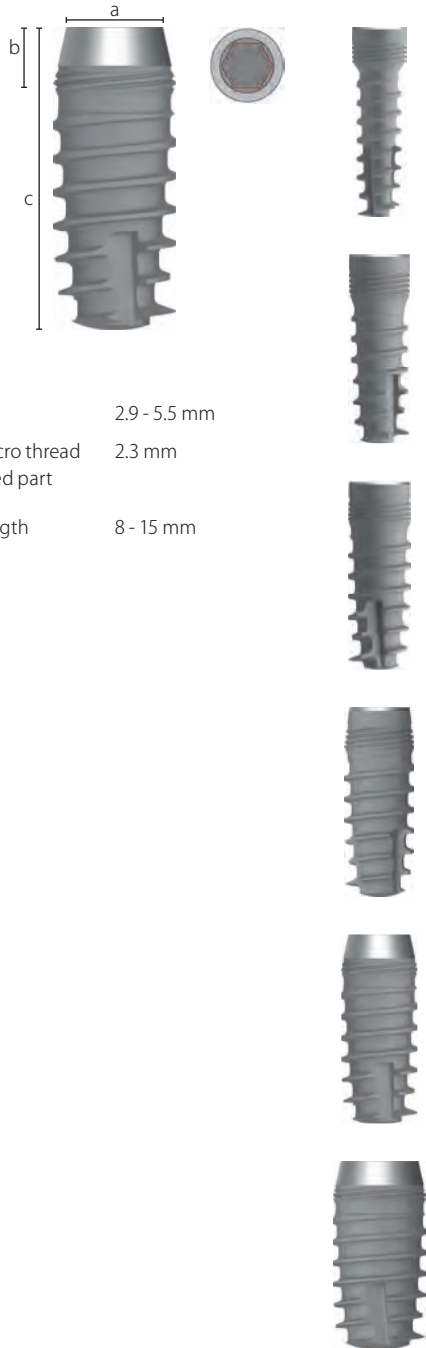

- a) Enossal Ø                    2.9 - 5.5 mm
- b) Length micro thread and polished part    2.3 mm
- c) Enossal length                8 - 15 mm

Description	Enossal Ø	Enossal length	REF	Price cat.
HC 2.9 13	2.9 mm	13 mm	413200	G
HC 2.9 15	2.9 mm	15 mm	413201	G
HC 3.3 8	3.3 mm	8 mm	413220	G
HC 3.3 10	3.3 mm	10 mm	413221	G
HC 3.3 11.5	3.3 mm	11.5 mm	413222	G
HC 3.3 13	3.3 mm	13 mm	413223	G
HC 3.3 15	3.3 mm	15 mm	413224	G
HC 3.7 8	3.7 mm	8 mm	413202	G
HC 3.7 10	3.7 mm	10 mm	413203	G
HC 3.7 11.5	3.7 mm	11.5 mm	413210	G
HC 3.7 13	3.7 mm	13 mm	413204	G
HC 3.7 15	3.7 mm	15 mm	413205	G
HC 4.1 8	4.1 mm	8 mm	413300	G
HC 4.1 10	4.1 mm	10 mm	413301	G
HC 4.1 11.5	4.1 mm	11.5 mm	413302	G
HC 4.1 13	4.1 mm	13 mm	413303	G
HC 4.5 8	4.5 mm	8 mm	413206	G
HC 4.5 10	4.5 mm	10 mm	413207	G
HC 4.5 11.5	4.5 mm	11.5 mm	413208	G
HC 4.5 13	4.5 mm	13 mm	413209	G
HC 5.5 8	5.5 mm	8 mm	413211	G
HC 5.5 10	5.5 mm	10 mm	413212	G
HC 5.5 11.5	5.5 mm	11.5 mm	413213	G
HC 5.5 13	5.5 mm	13 mm	413214	G

Delivery inclusive surgical screw CSTI, REF 418101



TRADITIONAL **HEXACONE® 6+2** IMPLANTS

**Hexacone® 6+2** was especially developed for the area of the 1<sup>st</sup> and 2<sup>nd</sup> molars in the upper and lower jaw. It is possible and recommendable to use it as a compression screw implant in the upper jaw. Endosseous length 6-8 mm (8 mm incl. reverse cone). The upper edge of the polished 75° reverse cone can end at bone level or slightly above it. **Hexacone® 6+2** implants have a laser-generated surface structure (No-Itis® laser) in the enossal area.

The conical polished implant head (a) should be submerged into the bone.



Description	Enossal Ø	Enossal length	REF	Price cat.
HC 4.5 6+2	4.5 mm	6 mm	413217	G
HC 5.5 6+2	5.5 mm	6 mm	413218	G

- a) Reverse conus            2 mm
- b) Enossal length        6 mm
- c) Enossal Ø                4.5 - 5.5 mm



Delivery inclusive surgical screw CSTI, REF 418101

**SURGICAL ACCESSORIES**

Description	Code	REF	Price cat.
 Gingivaformer for 3 mm gingival height	<b>HSI 3</b>	418111	B
 Gingivaformer for 5 mm gingival height	<b>HSI 5</b>	418112	B
 Wide Gingivaformer for 3 mm gingival height	<b>HSIW 3</b>	418191	B
 Wide Gingivaformer for 5 mm gingival height	<b>HSIW 5</b>	418192	B
 Anatomical Gingivaformer 3 mm high, 4.5 mm wide	<b>HSI 3-4.5</b>	418268	B
 Anatomical Gingivaformer 3 mm high, 5.5 mm wide	<b>HSI 3-5.5</b>	418269	B
 Anatomical Gingivaformer 5 mm high, 6.7 mm wide	<b>HSI 5-6.7</b>	418270	B
 Gingivaformer 3 mm high, 3.3 mm wide	<b>HSIS 3-3.3</b>	418277	B

Screwable abutments for cemented bridges, without anti-rotation protection. Trimming and grinding is possible. Tighten with **HT 1.25**. Recommended insertion torque **20 Ncm**.

	Description	Code	REF	Price cat.
	Height above implantat 8.5 mm The impression is made directly on the TCA, with tool TZ HC	TCA	418129	B
	The impression is made directly on the TCA W	TCA W	418173	B

Superstructure with hex and screw. Straight, for cemented bridges, without anti-rotation protection. Trimming and grinding is possible. Tighten with **HT 1.25**. Delivery inclusive screw **SF 20**. Recommended insertion torque **20 Ncm**.



	Description	Code	REF	Price cat.
	Abutment, height above implantat 8.5 mm	TLA HC	418133	D
	Abutment, narrow, for HC 2.9	TLAS	418134	D
	Abutment with 2 mm gingival height	TLA HC2	418170	D
	Abutment with 4 mm gingival height	TLA HC4	418171	D

	Description	Code	REF	Price cat.
	Abutment	TLA W	418193	D
	Anatomical abutment	ANAB	418276	E

	Description	Code	REF	Price cat.
	15° angled, 1 mm gingival height	TLA15 HC1	418135	F
	15° angled, 2 mm gingival height	TLA15 HC2	418136	F
	15° angled, 3 mm gingival height	TLA15 HC3	418137	F
	25° angled, 1 mm gingival height	TLA25 HC1	418139	F
	25° angled, 2 mm gingival height	TLA25 HC2	418140	F
	25° angled, 3 mm gingival height	TLA25 HC3	418141	F







Delivery inclusive screw SF 20



	Description	Code	REF	Price cat.
	Castable abutment for TLA HC2/4	PA TLA HC	418172	A
	Castable abutment For TLA HC and TCA	PA U	418181	A
	Transfer post For TLA HC and TCA	TZ HC	418179	A



**IMPRESSION TAKING AND LABORATORY ACCESSORIES**

	<b>Description</b>	<b>Code</b>	<b>REF</b>	<b>Price cat.</b>
	Impression post Click-on No screw is needed	HLTC	418107	C
	Impression post For TLA, TLA 15 and TLA 25 For Pick-up, with screw	HLT	418108	C
	Pick-up screw For HLT REF 418108	SF HLT long	418185	B
	Impression post for HC Height 10.6 mm	TS HC	418109	C
	Impression post for HC Height 15.5 mm	TSL HC	418110	C
	Long impression post With screw	HLTS	418118	C
	Lab analogue For Hexacone®	IA HC	418113	B

**DIGITAL IMPRESSION TAKING**

	<b>Description</b>	<b>Material</b>	<b>Unit</b>	<b>Code</b>	<b>REF</b>	<b>Price cat.</b>
	Scanbody for digital impression taking Screw SF 20 is optional and must be ordered separately	POM	Pack of 5	Scanbody HC	418288	B

Screwable spacer abutment for bridges and bars. Tighten with **HT 1.77**. Recommended insertion torque **25 Ncm**.



#### Description

For gingival height 3 mm

For gingival height 4 mm

For gingival height 5 mm

For gingival height 6 mm

#### Code

TSA 3

TSA 4

TSA 5

TSA 6

#### REF

418143

418144

418145

418146

#### Price cat.

B

B

B

B



#### Description

Impression post

TSA analogue

Castable abutment  
10.5 mm high  
Pack of 5

Screw for fixation  
PSS on BTS/TSA

#### Code

TS

BTS

PSS (white)

SF

#### REF

418142

418152

418151

#### Price cat.

B

B

B

B

Screwable mesostructure for bridges and bars. Tighten with **HT 1.77**. Recommended insertion torque **25 Ncm**. The position of the TCT hex is assigned with this approach.



#### Description

For gingival height 0.5 mm

For gingival height 1.5 mm

For gingival height 2.5 mm

#### Code

TCT HC 0.5

TCT HC 1.5

TCT HC 2.5

#### REF

418130

418131

418132

#### Price cat.

B

B

B



#### Description

Transfer post

Long screw

TCT analogue

Castable abutment  
12 mm high  
Internally round  
Pack of 5

Castable abutment  
12 mm high  
Internally edged  
Pack of 5

Screw for fixation

#### Code

TST

SFL

BTT

PSTR (grau)

PSTA

SF

#### REF

418147

420428

418100

418124

418123

418151

#### Price cat.

B

B

B

B

B

B

**TCT SET**

This set contains all necessary components for the mesiostructure. For bridges and bars. Screwable (anti-rotation).



Hex

**Description**

Screw for PSTA

Castable abutment, 12 mm high  
Internally edged  
Mesiostructure for bridges and bars, screwable

**COMPLETE SET**

**Code**

SF TCTL

PSTA

TCTL 0.5

**REF**

418165

418123

418138

418263

**Price cat.**

B

B

D

F



**Description**

Lab analogue  
For Hexacone®

Long transfer post  
For HC and HC2, with Hex

Short transfer post  
For HC and HC2, with Hex

Castable abutment, round,  
12 mm high  
Pack of 5

**Code**

IA HC

HLTS

HLT

PSTR

**REF**

418113

418118

418108

418124

**Price cat.**

B

C

C

B

**HEX REVERSE ABUTMENT**

This abutment converts the internal hexagon of the Hexacone® implants into an external standard-hexagon. The prosthetic screw is screwed through. It tightens the prosthetic and the abutment at the same time.

SF 275



**Description**

Tempbase for HRA HC

Hex reverse abutment  
Incl. screw SF 275 REF 418275

**Material**

PEEK

Ti6Al4V

**Code**

TPBE

HRA HC

**REF**

418274

418273

**Price cat.**

C

D

**LOCALICER®**

We recommend a minimum of six implants per jaw and the use of a single denture as splint when using LOC abutments. Tighten with **HT 1.77**.

**Description**

Localicer® for Hexacone®

**Height**

2 mm

**Code****LOCHC 2****REF****418116****Price cat.****C**

Localicer® for Hexacone®

4 mm

**LOCHC 4****418117****C****ACCESSORIES FOR LOCALICER®****Description**

Analogue + impression set

**Code****AA LOC****REF****462337****Price cat.****C**

Set with 5 caps + 1 housing (EXTERNAL PRODUCT)

**NCS****462338****D****Pull-off force**

Yellow 600 g, Pink 1.200 g, Transparent 1.800 g, Violet 2.700 g  
 Black has no retention and is designed for temporary solutions for up to one month







**TITANIUM BASE FOR CAD/CAM****Description**Titanium base  
Incl. screw**Type**Abutment base for zirconium  
Anti-rotation  
Material Ti6Al4V**Code****MB HC****REF****418267****Price cat.****D**

**MULTI-UNIT ABUTMENTS**

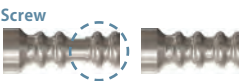
Insertion of the angled MU2 abutments with **HT 1.25**. Insertion of the straight MU2S abutments with **HT 1.77**. Not for use on single implant constructions.

	Description	Material	Code	REF	Price cat.
	Abutment 17° angled Incl. screw SF 20	Ti6Al4V	<b>MU2 17 HC</b>	<b>418281</b>	<b>L</b>
	Abutment 35° angled Incl. screw SF 20	Ti6Al4V	<b>MU2 35 HC</b>	<b>418282</b>	<b>L</b>
	Abutment straight Gingiva height 0.5 mm	Ti6Al4V	<b>MU2S 0.5 HC</b>	<b>418283</b>	<b>G</b>
	Abutment straight Gingiva height 1.5 mm	Ti6Al4V	<b>MU2S 1.5 HC</b>	<b>418284</b>	<b>G</b>
	Abutment straight Gingiva height 2.5 mm	Ti6Al4V	<b>MU2S 2.5 HC</b>	<b>418285</b>	<b>G</b>
	Gingivaformer incl. SF MU2 Height above abutment shoulder 6 mm	Ti6Al4V	<b>GF MU 2</b>	<b>418286</b>	<b>C</b>
	Localicer® incl. SF MU2 Height above abutment shoulder 6.7 mm Use with NCS Set REF 462338	Ti6Al4V	<b>MU 2</b>	<b>418287</b>	<b>C</b>
	Prosthetic screw for MU2 Extends into the implant	Ti6Al4V	<b>SF 20</b>	<b>420943</b>	<b>B</b>

**ACCESSORIES FOR MULTI-UNIT ABUTMENTS**

	Description	Material	Code	REF	Price cat.
	Temporary base SF MU2 sold separately	Ti6Al4V	<b>TC MU2</b>	<b>418290</b>	<b>D</b>
	Transfer straight incl. screw SFL MU2	Ti6Al4V	<b>TS MU2</b>	<b>418291</b>	<b>C</b>
	Castable for Multi-Unit incl. screw TC MU2 for UCLA on the MU2 abutment		<b>PA MU2</b>	<b>418292</b>	<b>A</b>
	Screw for TC MU2	Ti6Al4V	<b>SF MU2</b>	<b>418293</b>	<b>B</b>
	Lab analogue for Multi-Unit	Ti6Al4V	<b>IA MU2</b>	<b>418295</b>	<b>B</b>
	Hex instrument long		<b>HT 1.25</b>	<b>425100</b>	<b>C</b>
	Hex instrument for all superstructures		<b>HT 1.77</b>	<b>425103</b>	<b>C</b>

## BALL ABUTMENT FOR REMOVABLE PROSTHETICS

**Description**

Ball abutment for fitting prostheses  
Application on TSA 3-6 abutments only  
Head diameter 2.5 mm

**Code**

SB

**REF**

418153

**Price cat.**

B

**Description**

Height above implantat  
3-6 mm

Impression post  
for TSA and TCA

TSA analogue

**Code**

TSA 3

TSA 4

TSA 5

TSA 6

TS

BTS

**REF**

418143

418144

418145

418146

418142

418152

**Price cat.**

B

B

B

**Description****Gingiva height****Code****REF****Price cat.**

0.5 mm

TB 0.5

418126

B



Ball abutment  
Head diameter 2.5 mm  
Tighten with **HT 1.25**  
Use with NC caps

2 mm

TB 2

418127

B



4 mm

TB 4

418128

B



## ACCESSORIES FOR BALLHEAD ABUTMENTS

**Description****Unit****Code****REF****Price cat.**

Nylon cap transparent, Pull-off force ca. 1200g  
(EXTERNAL PRODUCT)

Pack of 2

NC

465028

A1



Nylon cap pink, Pull-off force ca. 800g  
(EXTERNAL PRODUCT)

Pack of 2

NC 1

465029

A1



Nylon cap yellow, Pull-off force ca. 500g  
(EXTERNAL PRODUCT)

Pack of 2

NC 2

465030

A1



Green, strong Nylon caps R-NC  
With increased friction strength  
Only with reduced diameter ball  
≤ 2.3 mm

Pack of 2

R-NC

465034

A1



Pink, medium

Pack of 2

R-NC 1

465033

A1



Orange, soft (EXTERNAL PRODUCT)

Pack of 2

R-NC 2

465032

A1



Metal sleeve for all nylon caps  
(EXTERNAL PRODUCT)





H

465031















B



**INSERTION TOOLS**

	Description	Type	Code	REF	Price cat.
	IT 2.5	8 mm, click-on, hexagon	IT 2.5	418174	B
	ITL 2.5	22 mm, click-on, hexagon	ITL 2.5	418175	B
	ITM 2.5	20 mm, click-on, hexagon	ITM 2.5	418176	B
	IT 2.5 M	Insertion tool For contra-angle	IT 2.5 M	418150	B
	ITWH 2.5 M	Insertion tool with hex For W&H contra-angle	ITWH 2.5 M	418184	C

**INSTRUMENTS AND TOOLS**

	Description	Type	Code	REF	Price cat.
	Hex instrument 1.25	21 mm	HT 1.25	425100	C
	Hex instrument 1.25	For contra-angle, 45 mm	HTW 1.25	425111	C
	Hex instrument 1.25	14 mm	HTS 1.25	425101	C
	Hex instrument 1.77	For all superstructures, 19 mm	HT 1.77	425103	C
	Hex instrument 1.25 M	For contra-angle, 26.1 mm	HT 1.25 M	425112	C
	Hex instrument 1.77 M	For contra-angle, 28.6 mm	HT 1.77 M	425113	C
	Hex instrument	45 mm, 1.25 Ø	HTX 1.25	425102	C
	Hex instrument	45 mm, 1.77 Ø	HTX 1.77	425104	C
	Punch	For contra-angle, 4.9 mm Ø	PUW1	425404	C
	Punch	Manual, 5.2 mm Ø	PU	425406	C
	Standardized probe	Scale 1 mm for X-ray measurements 22 mm	PDG	425400	A
	Drill extension contra-angle	Extends by 19 mm	DX2	500704	D
	Guide sleeve	For pilot drill, Titan, 10 mm, 2.2 mm Ø Pack of 5	BFH	425401	B
	X-ray measuring sphere	Surgical steel, 0.5 mm Ø Pack of 5	RM	425403	A

## GUIDE JACKET

**Description**

BFH 2.0 guide jacket 2.0 mmd

**Unit**

Pack of 5

**Material**

Ti6Al4V

**REF**

425410

**Price cat.**

B



BFH 2.5 guide jacket 2.5 mmd

Pack of 5

Ti6Al4V

425411

B



BFH 3.0 guide jacket 3.0 mmd

Pack of 5

Ti6Al4V

425412

B



BFH 3.2 guide jacket 3.2 mmd

Pack of 5

Ti6Al4V

425413

B



BFH 3.5 guide jacket 3.5 mmd

Pack of 5

Ti6Al4V

425414

B

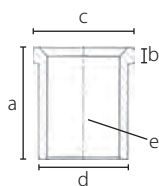

a) Length

5 mm

b) Height of step

0.7 mm

c) Max. Ø top

3.7 - 5 mm

d) Nominal Ø

3 - 4.4 mm

e) Ø of drilling in the drill template

2.05 - 3.55 mm



Model with residual teeth for the fabrication of a drill guide for creating cavities for fixing the later drill guide for implant cavities.



Drill guide for creating cavities for later fixation of the surgical drill guide.



Surgical drill guide for safe BCS® placement. The drill sleeves are designed for 2.0 mm Twist drills.



**HANDGRIP TRAY**



**Description**

Adapter

**Type**

For all contra-angle instruments  
For handgrip

**Code**

**Adapter Wst**

**REF**

**310530**

**Price cat.**

**C**



Adapter for handgrip

**Adapter IT HC**

**418196**

**C**



Handgrip

For machine reprocessing, cannot be dismantled  
Clean in an ultrasonic bath at 45° with an alkaline cleaning agent  
For adapter, self-locking

**Handgrip**

**311431**

**V**

To clean this tool a heatable ultrasonic bath and a thermo disinfectant (i.e. Miele TD-Serie) are required.



**HANDGRIP TRAY** w/o content

Size of closed tray:

**W** 195 mm **D** 90 mm **H** 45 mm

**REF 60043**

**Price cat. K**

For safe storage and sterilization of handgrips (max. 3 pieces) and adapters (max. 8 pieces). Plastic, autoclaveable up to 134° C, not suitable for dry heat sterilizers.

-55%  
heat**HEATLESS® DRILLS** FOR IMPLANTS WITH CONICAL CORE

Surgical steel, color-coded, depth-coded and autoclaveable. The drill is marked with laser depth markings. Use between 3,000 and 5,000 rpm with good cooling and intermittent drill technique.

Due to the extremely high cutting performance, you can work without pressure.

For the implant systems Hexacone® and Xign®. Drill types DFN 3.0 - DFN 4.2-4.5.

	Ø working range	Max. working depth	Total length	Colour	Code	REF	Price cat.
	0.1 - 1.5 mm	15 mm	31.7 mm	yellow	BCD 1	900240	C
	0.1 - 1.5 mm	15 mm	42 mm	yellow	BCDX 1	900243	C
	2.0 / 3.6 mm	13 mm	30 mm	-	DFN 2.9 13	418102	E
	2.0 / 3.6 mm	15 mm	32 mm	-	DFN 2.9 15	418103	E
	2.0 mm	17 mm	32.5 mm	-	DS 2	425001	D
	2.8 mm	17 mm	36.5 mm	-	DS 2.8	425005	D
	2.8 mm	25 mm	44.5 mm	-	DSL+ 2.8	425015	E
	2.7 mm	18 mm	36 mm	brown	DFN 3.0	425030	E
	3.0 mm	18 mm	36 mm	grey	DFN 3.4	425031	E
	3.4 mm	18 mm	36 mm	yellow	DFN 3.7	425032	E
	3.5 mm	18 mm	36 mm	green	DFN 4.1	425049	E
	4.05 mm	18 mm	36 mm	blue	DFN 4.2 - 4.5	425033	E
	4.4 mm	18 mm	36 mm	red	DFN 5.5	425034	E
	2.7 mm	18 mm	39 mm	brown	DFLN 3.0	425035	E
	3.0 mm	18 mm	39 mm	grey	DFLN 3.4	425036	E
	3.4 mm	18 mm	39 mm	yellow	DFLN 3.7	425037	E
	4.05 mm	18 mm	39 mm	blue	DFLN 4.2 - 4.5	425038	E
	3 mm	25 mm	43.5 mm	grey	DFLN+ 3.4	425029	E
	3.4 mm	11.5 mm	30 mm	yellow	DFSN 3.7	425039	D
	3.9 mm	11.5 mm	30 mm	blue	DFSN 4.2 - 4.5	425040	D
	max. 3.8 mm	max. 5 mm	27 mm	yellow	CDrill 3.7	425043	D
	max. 4.1 mm	2.5 mm	27 mm	green	CDrill 4.1	425050	D
	max. 4.6 mm	max. 5 mm	27 mm	blue	CDrill 4.2 - 4.5	425044	D
	max. 5.5 mm	2.5 mm	27 mm	red	CDrill 5.5	425045	D

**IT HAS BEEN SCIENTIFICALLY PROVEN**

that **Dr. Ihde Dental Heatless® Drills generate 55% less heat** compared to traditional bone drills by other manufacturers. This enables higher rotational speeds: We recommend between 3.000 and 5.000 RPM with good external cooling and intermittent drill technique.

## INSTRUMENT TRAY

Autoclaveable up to 134° C. Not suitable for dry heat sterilizers. Size of closed tray: **W** 175 mm **D** 145 mm **H** 65 mm



Description	Code	REF	Description	Code	REF	Price €
Twist drill	BCD 1	900240	Insertion tool short	IT 2.5	418174	
Twist drill	DS 2	425001	Insertion tool medium	IT 2.5 M	418150	
Twist drill	DS 2.8	425005	Universal adapter	UAW	425107	
Form drill	DFN 2.9 13	418102	Hex instrument 1.25 long	HT 1.25	425100	
Form drill	DFN 2.9 15	418103	Hex instrument 1.25 short	HTS 1.25	425101	
Form drill	DFN 3.0	425030	Hex instrument 1.77	HT 1.77	425103	
Form drill	DFN 3.7	425032	Punch	PUW 1	425404	
Form drill	DFN 4.2 - 4.5	425033	Drill extension	DX 2	500704	
Form drill	DFN 5.5	425034	Standardized probe	PDG	425400	
Form drill	DFSN 3.7	425039	Standardized probe	PDG	425400	
Form drill	DFSN 4.2 - 4.5	425040	Standardized probe	PDG	425400	
Cortical drill	CDrill 3.7	425043	Twist drill	DFLN 3.0	425035	
Cortical drill	CDrill 4.2 - 4.5	425044	Twist drill	DFLN 3.7	425037	
Cortical drill	CDrill 5.5	425045	Twist drill	DFLN 4.2 - 4.5	425038	
Insertion tool long	ITL 2.5	418175	Torque wrench	TW2	425402	
			Tray with content		560017-K	upon request
			Tray w/o content		60017-K	upon request

## DRILLSTOP TRAY

Not suitable for dry heat sterilizers.



Description	Code	REF	Price €
Drillstop A		500881	
Drillstop C		500883	
Drillstop D		500884	
Drillstop E		500885	
Drillstop G		500887	
Drillstop I		500889	
Drillstop J		500890	
Drillstop K		500891	
Drillstop L		500892	
Form drill	DFN 3.0	425030	
Form drill	DFN 3.4	425031	
Form drill	DFN 3.7	425032	
Form drill	DFN 4.1	425049	
Form drill	DFN 4.2 - 4.5	425033	
Form drill	DFN 5.5	425034	
Form drill	DFLN 3.0	425035	
Form drill	DFLN 3.4	425036	
Form drill	DFLN 3.7	425037	
Form drill	DFLN 4.2 - 4.5	425038	
<b>Tray with content</b>		<b>60031-K</b>	<b>739.00</b>

## STARTER tray

This surgical kit contains all drills and tools for first works with the Hexacone® system. Material: Plastic. Autoclaveable up to 134° C. Not suitable for dry heat sterilizers.



Description	Code	REF	Price €
Insertion tool	IT 2.5	418174	
Insertion tool	ITL 2.5	418175	
Insertion tool	ITM 2.5	418176	
Hex instrument long	HT 1.25	425100	
Twist drill	DS 2.0	425001	
Twist drill	DS 2.8	425005	
Form drill	DFN 3.0	425030	
Form drill	DFN 3.4	425031	
Form drill	DFN 3.7	425032	
Form drill	DFN 4.1	425049	
Form drill	DFN 4.2-4.5	425033	
Corticalis drill 3.7	C-Drill 3.7	425043	
Corticalis drill 4.1	C-Drill 4.1	425050	
Corticalis drill 4.2 - 4.5	C-Drill 4.2 - 4.5	425044	
Torque wrench	TW2	425402	

<b>Starter tray for Hexacone® with content</b>	<b>560021-K</b>	<b>upon request</b>
<b>Starter tray for Hexacone® w/o content</b>	<b>60021-K</b>	<b>upon request</b>

THE ADVANTAGES OF HEXACONE® PLUS MU 0° AND 15° IMPLANTS



For occlusal screwed prosthetics

Polished area with micro thread for optimal primary stability and tightening

Secure anti-rotation through high precision internal hexagon

Apical expanded bone thread

Excellent stability in all bone qualities: double condensation

Universal application for fixed and removable prosthodontics

Abutment alignment and 100% tightness through the taper

Can be anchored bicortical

## HEXACONE® PLUS MU 0° IMPLANTS

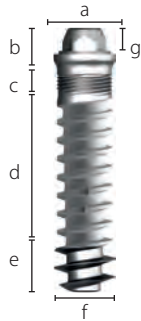

a) Platform Ø	4.8 mm
b) Head height	2.6 mm
c) Length micro thread	1.5 mm
d) Enossal length	10 - 23 mm
e) Height apical thread	3.2 mm
f) Max. enossal Ø	3.3 / 4.1 mm
g) Connecting part	2 mm

Max. insertion torque 35 Ncm Material Ti6Al4V



Description	Max. nominal Ø / without apical thread	Max. nominal Ø / with apical thread	Enossal length	REF	Price cat.
HC Plus MU 3.3 13 0°	3.3 mm	4 mm	13 mm	412250	G
HC Plus MU 3.3 15 0°	3.3 mm	4 mm	15 mm	412251	G
HC Plus MU 3.3 17 0°	3.3 mm	4 mm	17 mm	412252	G
HC Plus MU 3.3 19 0°	3.3 mm	4 mm	19 mm	412253	G
HC Plus MU 3.3 21 0°	3.3 mm	4 mm	21 mm	412254	G
HC Plus MU 3.3 23 0°	3.3 mm	4 mm	23 mm	412255	G
HC Plus MU 4.1 10 0°	4.1 mm	4.7 mm	10 mm	412259	G
HC Plus MU 4.1 13 0°	4.1 mm	4.7 mm	13 mm	412260	G
HC Plus MU 4.1 15 0°	4.1 mm	4.7 mm	15 mm	412261	G
HC Plus MU 4.1 17 0°	4.1 mm	4.7 mm	17 mm	412262	G
HC Plus MU 4.1 19 0°	4.1 mm	4.7 mm	19 mm	412263	G
HC Plus MU 4.1 21 0°	4.1 mm	4.7 mm	21 mm	412264	G
HC Plus MU 4.1 23 0°	4.1 mm	4.7 mm	23 mm	412265	G

## Description

Insertion tool incl. screw REF 418316. For Hexacone Plus MU.

## Code

IT HCMU

## REF

418315

## Price cat.

F



## HEXACONE® PLUS MU 15° IMPLANTS

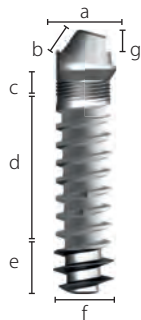

a) Platform Ø	4.8 mm
b) Head height	3.9 mm
c) Length micro thread	1.5 mm
d) Enossal length	10 - 23 mm
e) Height apical thread	3.2 mm
f) Max. enossal Ø	3.3 / 4.1 mm
g) Connecting part	2 mm

Max. insertion torque 35 Ncm Material Ti6Al4V

Description	Max. nominal Ø / without apical thread	Max. nominal Ø / with apical thread	Enossal length	REF	Price cat.
HC Plus MU 3.3 13 15°	3.3 mm	4 mm	13 mm	412225	G
HC Plus MU 3.3 15 15°	3.3 mm	4 mm	15 mm	412226	G
HC Plus MU 3.3 17 15°	3.3 mm	4 mm	17 mm	412227	G
HC Plus MU 3.3 19 15°	3.3 mm	4 mm	19 mm	412228	G
HC Plus MU 3.3 21 15°	3.3 mm	4 mm	21 mm	412229	G
HC Plus MU 3.3 23 15°	3.3 mm	4 mm	23 mm	412230	G
HC Plus MU 4.1 10 15°	4.1 mm	4.7 mm	10 mm	412235	G
HC Plus MU 4.1 13 15°	4.1 mm	4.7 mm	13 mm	412236	G
HC Plus MU 4.1 15 15°	4.1 mm	4.7 mm	15 mm	412237	G
HC Plus MU 4.1 17 15°	4.1 mm	4.7 mm	17 mm	412238	G
HC Plus MU 4.1 19 15°	4.1 mm	4.7 mm	19 mm	412239	G
HC Plus MU 4.1 21 15°	4.1 mm	4.7 mm	21 mm	412240	G
HC Plus MU 4.1 23 15°	4.1 mm	4.7 mm	23 mm	412241	G

## Description

Insertion tool for KOS MU, BCS MU and Hexacone Plus MU 15°. Use with IT2 BCS, IT2 S BCS, AH-MU, for handgrip. Tool for screw: HT 1.25.

## Code

ITX MU15

## REF













418203

## Price cat.



G







## ACCESSORIES

	Description	Code	REF	Price cat.
	Insertion tool for Hexacone® Plus MU 0°	IT HCMU	418315	F
	Insertion tool for Hexacone® Plus MU 15° Use with IT2 BCS, IT2 S BCS, AH-MU	ITX MU15	418203	G
	Hex instrument 1.25, length 21 mm For fixation of Insertion tool ITX MU 15	HT 1.25	425100	C
	Adapter for handgrip For ITX MU15 (REF 418203)	AH-MU	900041	F
	Castable abutment Use with T-Base and SF KMU	PA2 MU	418189	B
	Lab analogue For MU implants	IA KMU	418159	B
	Prosthetic screw	SF KMU	418164	B
	Transfer for Pick-Up Straight Delivery incl. SFL MU	HLT MU	418162	C
	Long screw for prosthetic use or as pick-up Tool: HT 1.25 Material Ti6Al4V	SFL MU	418168	B
	Castable abutment UCLA For direct use on MU implants SF K MU sold separately	PA MU	418119	B
	Transfer Coping (Temporary base) SF K MU sold separately	TC MU	418161	D
	Scan abutment for MU implants Incl. screw SSA MU. Sterilisable, two-part Material Ti6Al4V	SAB MU	418205	D

## ACCESSORIES FOR HEXACONE® PLUS MU

	Description	Code	REF	Price cat.
	Ratchet for all Hex instruments and insertion tools	RAT 2	425051	K
	Torque wrench 10 - 70 Ncm. <b>It is recommended to have the torque ratchets recalibrated by us once a year.</b>	TW2	425402	S

## SCANBODIES

	Description	Systems	Material	Unit	Code	REF	Price cat.
 Top view 	Scanbody-MU cylindrical	BCS® MU KOS® MU Hexacone® MU	POM	Pack of 5	Scanbody-MU	462056	B
 Top view 	Flag-Scanbody SCB MU incl. screw SFK MU (REF 418164) For intra-oral scans	BCS® MU KOS® MU Hexacone® MU	POM	Pack of 1	SCB MU	462073	B

Please go to <http://simpladent-implant.com/en/stl> to download the corresponding STL files.







# IHDE DENTAL

(The products of this catalogue are CE marked (class I) and CE 1936 marked (class IIa and IIb) according to 93/42/EC Directive).

Commercial products that are not monitored by our notified body are declared as third-party products.

We are certified DIN EN ISO 13485, and annex II of EEC Directive 93/42 EWG (2007).  
Due to technical reasons the product dimensions shown in this brochure might deviate from reality.

**Hexacone®** is a registered trademark.

**Hexacone®** implants are patent-protected.

In case that implants would be reprocessed (cleaned, resterilized) infections could occur, because no validated procedures for reprocessing are available.

## Compilation and clarification of symbols on the pack:



Batch No.



Sterilized by  
gamma radiation



Non-sterile



Intended for use  
by dentists or  
surgeons only



Single use  
product



Instruction  
for use



Expiry date



Store  
in a dry  
place



Store tightly  
keep closed



Do not use if  
packing is  
damaged



Do not  
resterilize



Manufacturer



Production  
date



Catalogue  
number



Secure anti-rotation through high precision internal hexagon

Apical expanded bone thread

Excellent stability in all bone qualities: double condensation

Universal application for fixed and removable prosthodontics

Abutment alignment and 100% tightness through the taper

**IHDE**DENTAL 

**Dr. Ihde Dental AG**  
Dorfplatz 11  
CH - 8737 Gommiswald / SG  
Tel +41 (0)55 293 23 23  
contact@implant.com  
www.implant.com

**Dr. Ihde Dental GmbH**  
Erfurter Str. 19  
D - 85386 Eching / Munich  
Tel +49 (0)89 319 761 0  
Fax +49 (0)89 319 761 33  
info@ihde-dental.de  
www.ihde-dental.de

6646\_HE\_EN\_20210311\_V051

