

**IHDE**DENTAL 

TWO PIECE IMPLANTS DENTAL IMPLANT  
SYSTEM  
**Xign**<sup>®</sup>



"FOR ME, IMPLANTOLOGY BEGINS  
WHERE OTHERS HAVE GIVEN UP."

- Dr. Stefan Ihde



Dr. Ihde Dental has been a reliable partner for over 60 years providing a wide range of implant systems and consumables. We supply dentists and dental technicians with precisely coordinated materials and systems, which are easy and reliable to use. We always ensure high quality and an excellent price-performance ratio so that you can guarantee allround treatment for your patients that is cost-effective and highly efficient. The following catalog gives you an overview and all the essential information about our implant systems. You can also contact us personally any time using the phone numbers provided. Further information can be found on our websites:

[www.implant.com](http://www.implant.com) || [www.ihde-dental.de](http://www.ihde-dental.de) || [www.ihde.com](http://www.ihde.com)

**The company** was founded in 1954 in Berlin by the dental technician Klaus Ihde. The company relocated to Bavaria in the 1960s. At the end of the 1980s, Dr. Ihde Dental GmbH (Germany) and Dr. Ihde Dental AG (Switzerland) were formed from the Klaus Ihde retail company. Ihde Dental is now represented in four locations in Europe and over 45 countries. The company group is one of the most innovative implant companies in the world – based on new developments and patents issued or pending.

**The core activities** of Ihde Dental are the development, procurement and distribution of medical products. We use a large number of suppliers in consumables, but we have produced implants in our own factory for many years. All components are manufactured quickly, precisely and economically thanks to state-of-the-art production technology and well-equipped machinery.

#### **Our partners**

Users and customers provide us with many new ideas and excellent suggestions. Collaboration with our customers is extremely important to us. Contact us at any time if you have any improvements or questions. Your ideas and opinions help us all to meet the daily wishes of patients to a greater and better extent. We also put the needs of the patient first..

#### **Our market performance and work ethic**

Since it was founded, the company has focused on innovative ideas and advanced technology, premium quality, an excellent price-performance ratio, optimal patient and user friendly products and durability. Our range combines the latest findings from research and practices in many countries around the world.

Customer orientated to us means – **available for you!**

- We provide training courses, refresher courses and user advice.
- We provide customers with comprehensive and technically sound advice.
- We also visit you in your practice upon request.

**Please call us to arrange an appointment  
or send us an email.**

**IHDE**DENTAL 

**Dr. Ihde Dental AG**  
Dorfplatz 11  
CH - 8737 Gommiswald / SG  
Tel. +41 (0)55 293 23 23  
contact@implant.com

**Dr. Ihde Dental GmbH**  
Erfurter Str. 19  
D - 85386 Eching / Munich  
Tel. +49 (0)89 319 761-0  
Fax +49 (0)89 319 761-33  
info@ihde-dental.de

# THE ADVANTAGES

OF THE ENDOSSEOUS DENTAL IMPLANT SYSTEM **XIGN®**

The Allfit® implant system **Xign®** is designed for enossal dental implantations. **Xign®** implants feature two high-precision internal cylindrical guides and hexagon. Implants with diameter 3.0 and 3.4 mm are not indicated for single tooth replacement. The **Xign®** implant system is suitable for single-step and dual-step implant protocols. **Xign®** accessory parts are colour coded.

The prescribed or recommended tightening torques for implants, abutments and screws can be found on our website:

[www.implant.com/en/downloads](http://www.implant.com/en/downloads)



Anti-rotation through precision internal hexagon and two telescoping areas

Excellent stability in all bone qualities

Universal application for permanent and removable prosthodontics

Made of highly resistant titanium alloy

Smart instrument tray

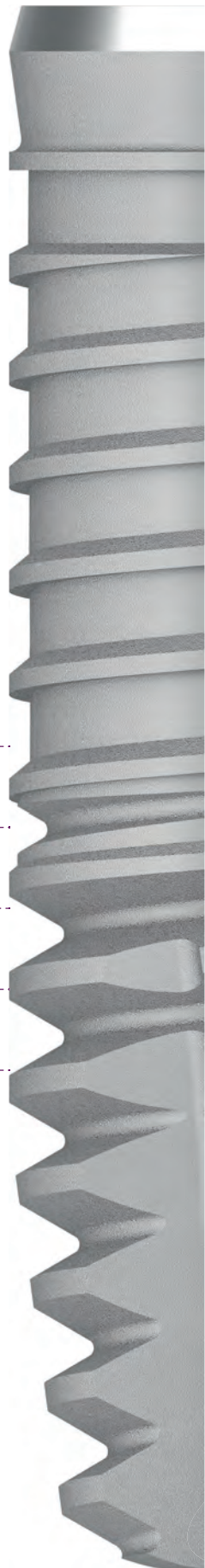



Polished area

Internal hexagon

Wide range  
of sizes



Colour coding  
of accessory parts  
according to  
implant Ø

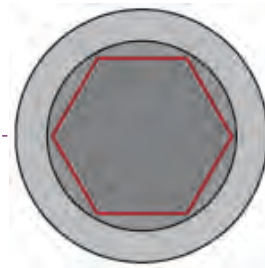

Enossal length  
Enossal Ø

6 - 15 mm  
3.0 - 5.5 mm



3.0 mm



3.4 mm



3.8 mm



4.5 mm



5.5 mm

## PRELIMINARY WORK FOR TEMPLATE APPLICATION

1. Ask your laboratory to prepare a drill template with boreholes for the pilot drill. To be on the safe side, you can ask the laboratory to insert guide sleeves (code BFH) into the template, which specify the exact drill direction. Please use a 2.0 Ø drill for the pilot drilling.
2. For the following drill sequences you can use drill stops, which can be attached and tightened to the drill according to the length of the drilling channel. Mucous membrane thickness and template height are taken into account as needed. Due to the extreme high cutting performance of our drills after the pilot drill the final drill may be used right away. In this case the drill sequence may be disregarded.

Recommended RPM: 2000-5000

Apply sufficient cooling and allow the cooling to reach the working blades of the drills.

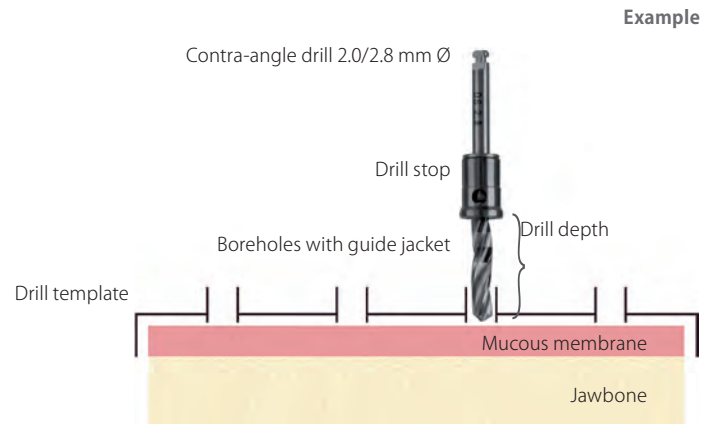

**GENERAL NOTE** Xign® implants with diameter 4.5 mm and larger are used as compression screws. In order to achieve a good bone condensation and implant stability, the drilling should be carried out thinner than the core diameter of the implant. The minimal diameter of the drill depends on the bone density. It is therefore not possible to advise drill-sequences which fit all bone-qualities. Typically in the soft maxillary bone only small drill-diameters are used (e.g. the usage of DOS1 only for larger Xign® implants), whereas in the highly mineralized lower jaw a specific drill sequence with respect to the mineralisation of the bone is necessary. For insertion under pressure use the handgrip.

## SURGERY

### 1. Recommended drill sequence (for contra-angle handgrip)

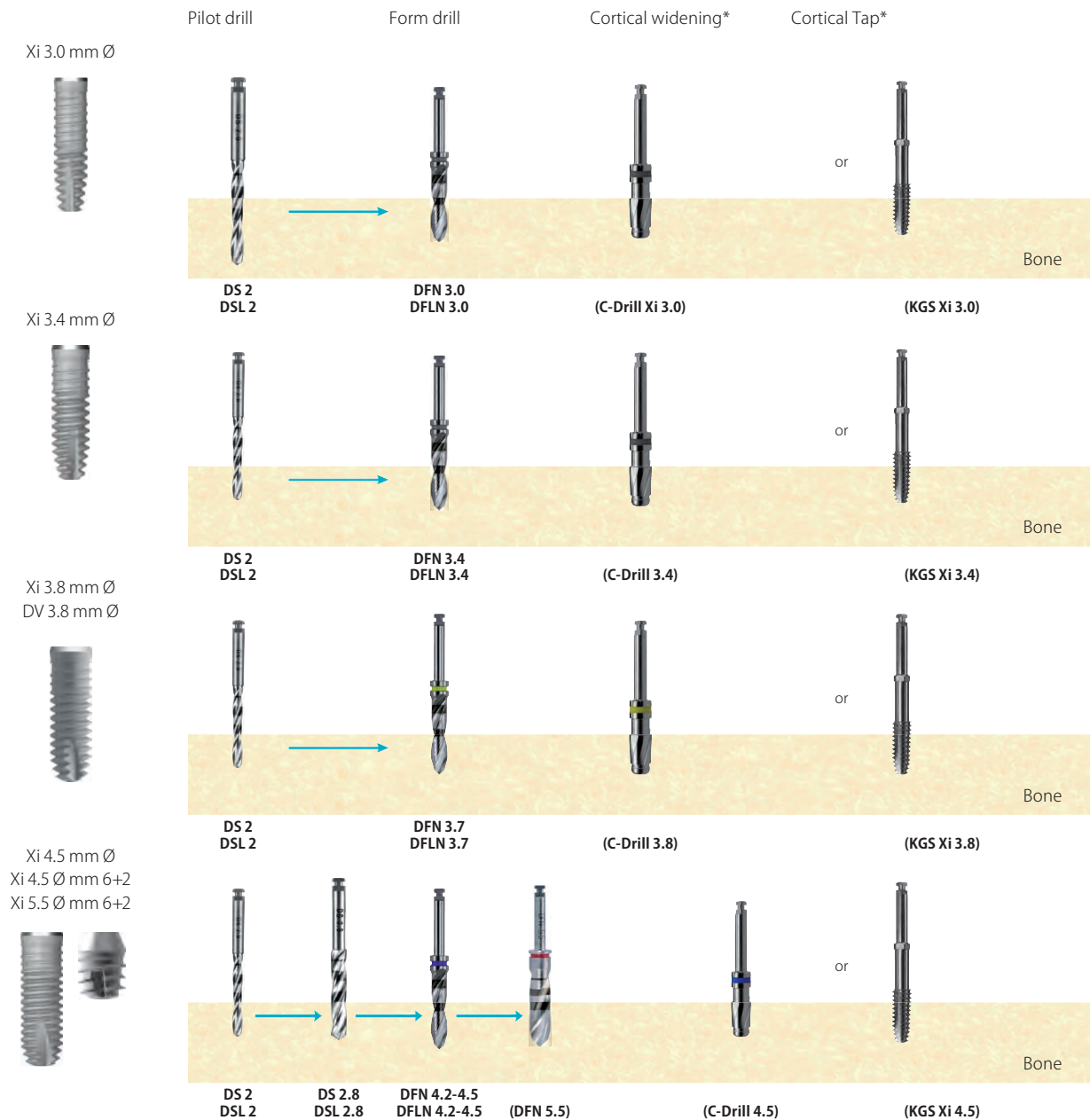

\*For areas with hard cortical bone, enlargement using a C-drill or Cortical Tap (KGS) is recommended down to a cortical depth of up to 6 mm. Form drills create the bone cavity for the respective implant. The actual diameter of the form drill is not mentioned in its order code (REF), as the drill corresponds to the diameter of the implants core.

## 2. Implant packaging



Original packaging



Open the blister using the flap. Remove the label and stick it into the patients record.



The blister (secondary packaging) contains the implant in a sterile tube (primary package).

## 3. Remove the implant from its packaging

1. Open the lid.
2. The implant is fixed to the lid by a break joint.
3. Remove the implant without touching the inner wall of the tube.

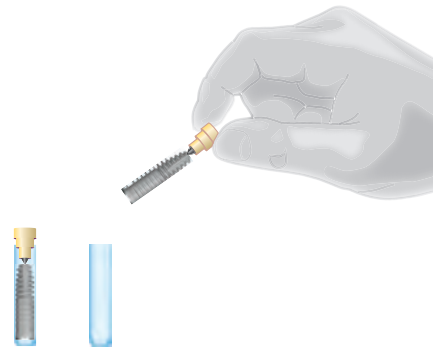

## 4. Handling

### 4.1 Connect

Attach the insertion tool to the implant by holding the lid, to which the implant is secured, with your other hand.

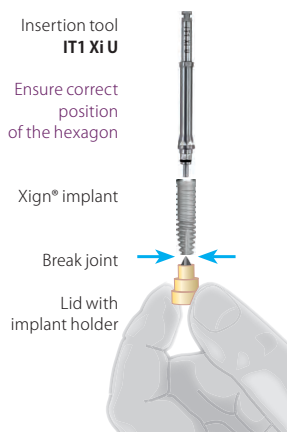

### 4.2

After you have attached the insertion tool, firmly hold the top in your hand and break the implant off the top along the break joint.

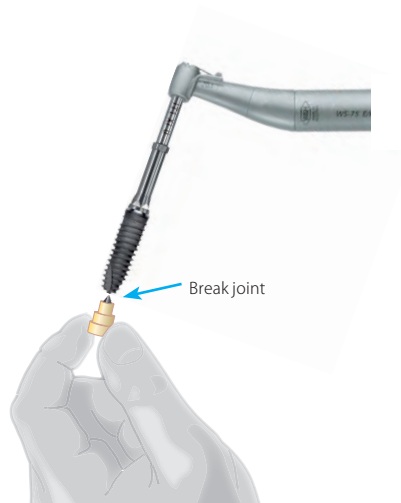

### 4.3

Using the contra-angle handpiece screw the implant clockwise into the cavity.

The enossal part of the implant must be completely covered by the bone. After insertion the implant can be turned by a 1/4 rotation backwards in order to relieve the bone and allow blood access to the implant surface.





### 5. Insertion

Release of the insertion tool or the contra-angle handpiece from the implant:

Pull insertion tool off the implant.

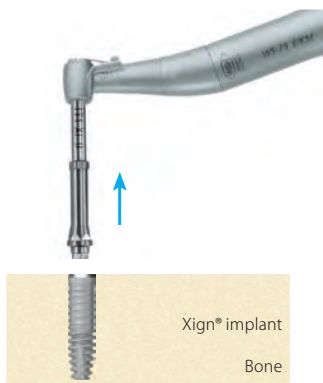

### 6. Result



### 7. Post-operative treatment

Seal the implant with a suitable cover screw.

After healing period: Remove cover screw.

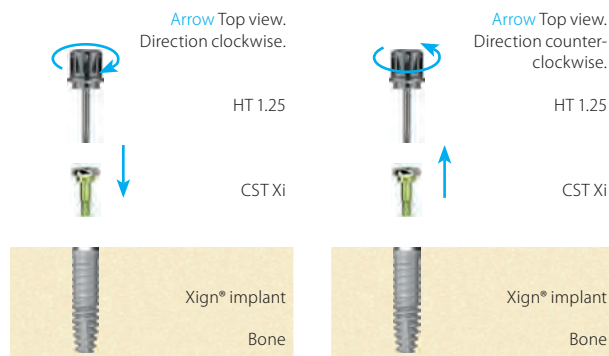

#### Max. insertion torque

- Xign 3.0 = 20 Ncm
- Xign 3.4 = 30 Ncm
- Xign 3.8 = 40 Ncm

### 8. Pick-up impressions

#### 8.1 Impression taking using an individual impression tray

Hex-instrument HT 1.25

Fastening of the impression post HLT Xi

Xign® implant

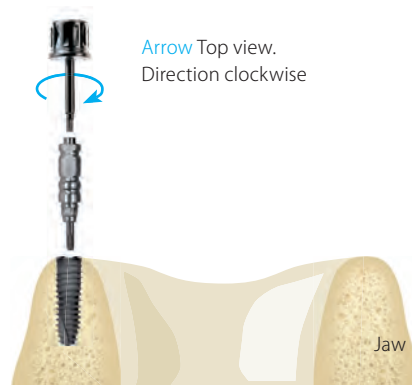

#### 8.2 Prior to the impression

Impression taking with an A silicone. The use of open and closed impression tray is possible.

The impression post HLT Xi must be unscrewed from the implant before the impression tray is removed from the patient's mouth.

Impression post HLT Xi

Xign® implant

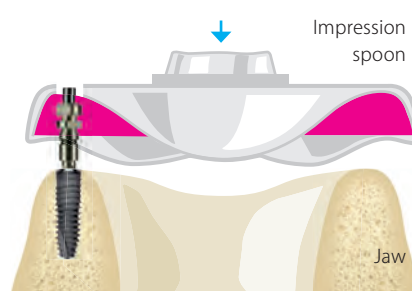

### 8.3 Remove impression

Disengage HLT Xi from the implant: HLT Xi remains in the impression.

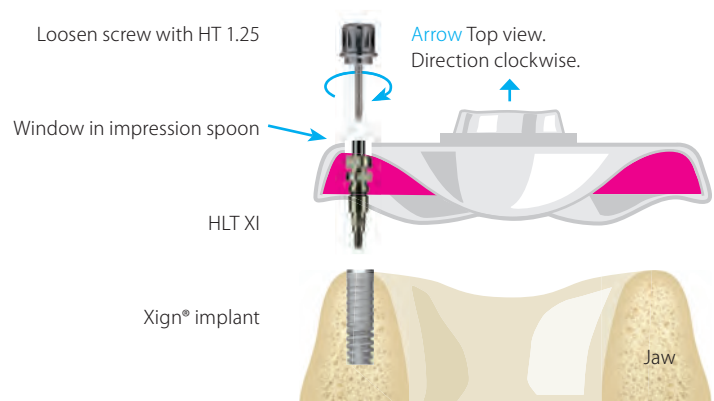

### 8.4

View of the impression post HLT Xi inside the impression (Pick up method, bottom view).

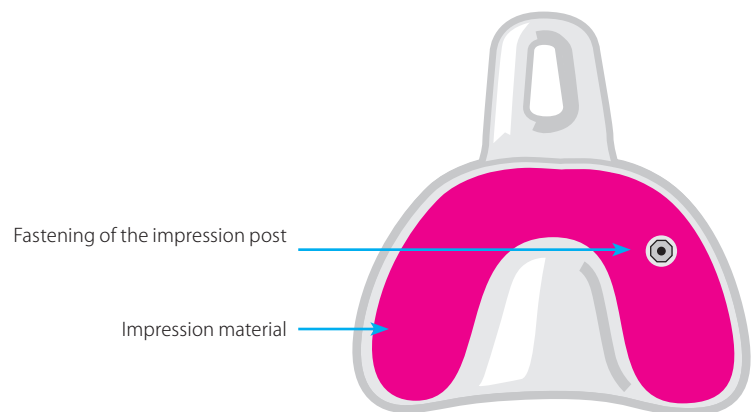

### 8.5

After the impression is taken, the implant is closed with a cover screw (Healing screw) and the impression is sent to the laboratory.

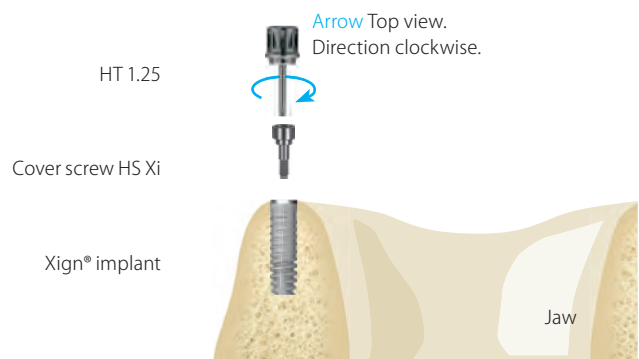

## 9. Impression taking with a closed impression spoon

### 9.1 Impression taking using an individual impression tray

Tighten the impression post with the top screw

TS(L) Xi

Xign® implant

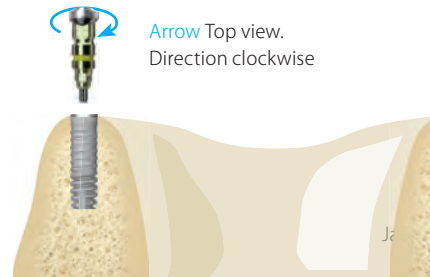

### 9.2 Prior to the impression

Impression taking with an A silicone The use of open and closed impression tray is possible.

Impression post  
TS(L) Xi

Xign® implant

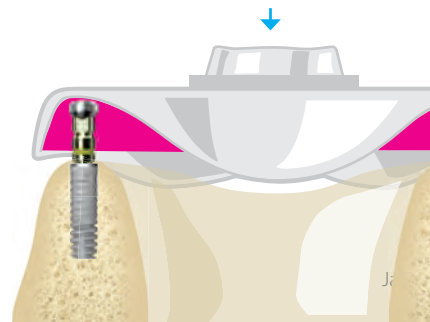

### 9.3 Remove impression

When the closed impression method is applied, then the impression post TS Xi remains on the implant after the impression tray is removed.

After removal of the impression tray the transfer-post TS(L) Xi is unscrewed.

TS(L) Xi

Xign® implant

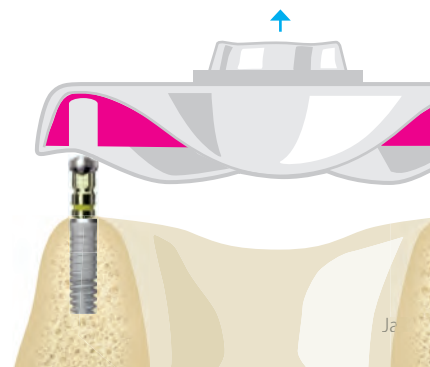

### 9.4

After the impression is taken, the implant is closed with a cover screw (i.e. Healing screw) and the impression is sent to the laboratory.

HT 1.25

Fasten Gingiva shaper HS Xi

Xign® implant

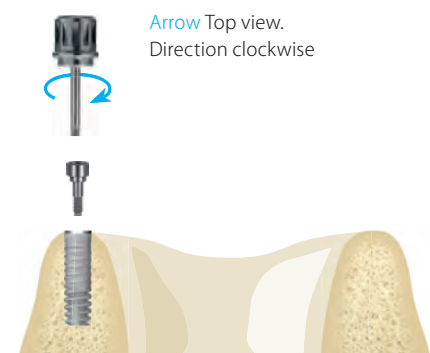

## 10. Preparation of the impression spoon for the model generation

### 10.1 Pick-up method

Screw analogue or M-analogue against the impression post.

Fasten the laboratory analogue in the impression using HT 1.25

HLT Xi

IA Xi or M-Analogue to Xign®

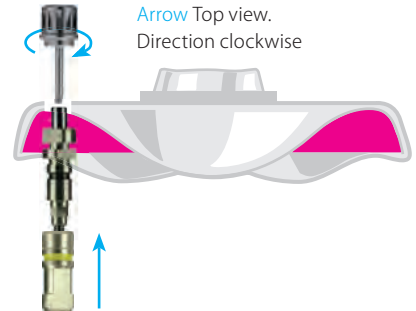

### 10.2 Closed method

Screw IA Xi or M analogue IA Xi against TS(L) Xi. Ⓐ Subsequently the impression post is repositioned in the impression. Ⓑ The impression can now be casted. In M analogues (IA Xi M) block the lower access to the lock screw out prior to casting.

Tighten the impression post onto the laboratory analogue using the topscrew

TS(L) Xi

IA Xi or IA Xi M

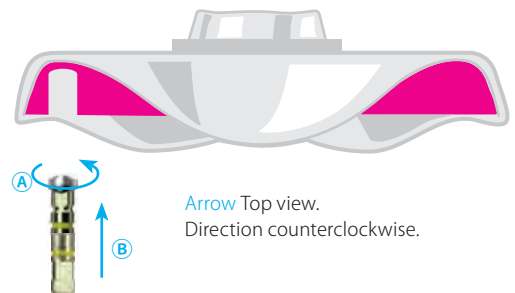

The impression is poured with impression putty. Afterwards the impression posts are unscrewed from the laboratory analogue.

Laboratory analogue  
Pour impression putty in

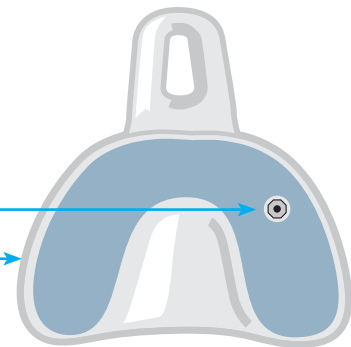

### 10.3

The laboratory analogue is now in the proper position and orientation in the gypsum.

IA Xi / IA Xi M  
IA DV



**10.4** Impression taking

Positioning of the screwed abutments TLA, whereupon the optimal position and adequate angulation must be determined.

**Note** The hexagon must be completely inserted into the analogue.

HT 1.25

Tighten screw

TLA 15 Xi

Ensure proper position of the hexagon

IA Xi / IA Xi M

**10.5**

Ensure proper position of the abutment when transferring into the mouth.

Tightening torque of the screw during fastening on the implant: 15 Ncm

TLA 15 Xi

**10.6**

If more than one angled abutment is used, your laboratory will prepare a detachable synthetic bar (e.g. Pattern Resin) in order to facilitate positioning in the mouth.

TLA 15 Xi

Pattern Resin



## XIGN® IMPLANTS



Xign® implants feature two high-precision internal cylindrical guides and hexagon. Material Ti6Al4V. implants with a diameter of 3.0 and 3.4 mm are not indicated for single tooth replacement. Delivery incl. corresponding surgical screw.

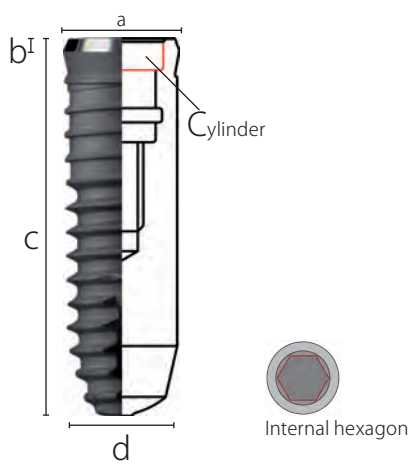

a) Max. head Ø 3.2 - 5.5 mm

b) Polished edge 0.35 - 2 mm

c) Enossal length 6 - 15 mm

d) Enossal Ø 3.0 - 5.5 mm

Xi 4.5 6+2 / Xi 5.5 6+2  
Compatible abutment size = 3.8

\* Premounted insertion aid included (TempBase®). Remove insertion aid with hex tool HT 0.9

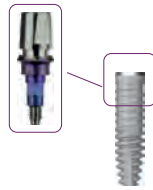

Description	Enossal Ø	Enossal length	REF	Price cat.
Xi 3.0 11.5 *	3.0 mm	11.5 mm	422000	N
Xi 3.0 13 *	3.0 mm	13 mm	422001	N
Xi 3.0 15 *	3.0 mm	15 mm	422002	N
Xi 3.4 8	3.4 mm	8 mm	422003	K
Xi 3.4 10	3.4 mm	10 mm	422004	K
Xi 3.4 11.5	3.4 mm	11.5 mm	422005	K
Xi 3.4 13	3.4 mm	13 mm	422006	K
Xi 3.4 15	3.4 mm	15 mm	422007	K
Xi 3.8 8	3.8 mm	8 mm	422008	K
Xi 3.8 10	3.8 mm	10 mm	422009	K
Xi 3.8 11.5	3.8 mm	11.5 mm	422010	K
Xi 3.8 13	3.8 mm	13 mm	422011	K
Xi 3.8 15	3.8 mm	15 mm	422012	K
Xi 4.5 6+2	4.5 mm	6 - 8 mm	422013	K
Xi 4.5 8	4.5 mm	8 mm	422014	K
Xi 4.5 10	4.5 mm	10 mm	422015	K
Xi 4.5 11.5	4.5 mm	11.5 mm	422016	K
Xi 4.5 13	4.5 mm	13 mm	422017	K
Xi 4.5 15	4.5 mm	15 mm	422018	K
Xi 5.5 6+2	5.5 mm	6 - 8 mm	422019	K

For implants with 3.0 mmd and 3.4 mmd the max. torque for the prosthetic screw is **13 Ncm**

For implants with 3.8 mmd the max. torque for the prosthetic screw is **20 Ncm**

For all other implants the max. torque for the prosthetic screw is **25 Ncm**

## COLOUR CODING



Implant Ø

3.0 mm

3.4 mm

3.8 mm

4.5 mm

5.5 mm

## SURGICAL SCREWS



Description	Code	REF	Price cat.
Surgical screw for 3.0 mm Ø, brown	CST Xi 3.0	422300	B
Tighten with <b>HT 0.9</b>			
Surgical screw for 3.4 mm Ø, silver	CST Xi 3.4	422301	B
Surgical screw for 3.8 mm Ø, yellow	CST Xi 3.8	422302	B
Surgical screw for 4.5 mm Ø, blue	CST Xi 4.5	422303	B
Tighten with <b>HT 1.25</b>			

## CYLINDRICAL GINGIVAFORMER



























Description	Code	REF	Price cat.
Gingivaformer 3.0 mm Ø, brown for 2 mm gingival height	HS Xi 3.0 2	422304	B
Gingivaformer 3.0 mm Ø, brown for 4 mm gingival height	HS Xi 3.0 4	422305	B
Tighten with <b>HT 0.9</b>			
Gingivaformer 3.4 mm Ø, silver for 2 mm gingival height	HS Xi 3.4 2	422306	B
Gingivaformer 3.4 mm Ø, silver for 4 mm gingival height	HS Xi 3.4 4	422307	B
Gingivaformer 3.8 mm Ø, yellow for 2 mm gingival height	HS Xi 3.8 2	422308	B
Gingivaformer 3.8 mm Ø, yellow for 4 mm gingival height	HS Xi 3.8 4	422309	B
Gingivaformer 4.5 mm Ø, blue for 2 mm gingival height	HS Xi 4.5 2	422310	B
Gingivaformer 4.5 mm Ø, blue for 4 mm gingival height	HS Xi 4.5 4	422311	B
Tighten with <b>HT 1.25</b>			

## ANATOMICAL GINGIVAFORMER



Description	Code (Height/Width)	REF	Price cat.
Gingivaformer 3.0 mm Ø, brown Height 4 mm, width at top 6 mm	HS Xi 3.0 H4W6	422480	B
Tighten with <b>HT 0.9</b>			
Gingivaformer 3.4 mm Ø, silver Height 4 mm, width at top 6 mm	HS Xi 3.4 H4W6	422481	B
Gingivaformer 3.8 mm Ø, yellow Height 4 mm, width at top 6 mm	HS Xi 3.8 H4W6	422482	B
Gingivaformer 4.5 mm Ø, blue Height 4 mm, width at top 6 mm	HS Xi 4.5 H4W6	422483	B
Tighten with <b>HT 1.25</b>			

## ABUTMENTS FOR CEMENTED PROSTHETICS

		Incl. screw	Description	Gingiva height	Colour	REF	Price cat.	
Straight		SF 2305	TLA Xi 3.0 2	2 mm	brown	422317	D	
			TLA Xi 3.0 3	3 mm	brown	422318	D	
			TLA Xi 3.0 5	5 mm	brown	422319	D	
		TLA Xi 3.4 1	SF 2301	TLA Xi 3.4 1	1 mm	silver	422320	D
				TLA Xi 3.4 2	2 mm	silver	422321	D
				TLA Xi 3.4 3	3 mm	silver	422322	D
				TLA Xi 3.4 5	5 mm	silver	422323	D
				TLA Xi 3.4 8	8 mm	silver	422324	D
				TLA Xi 3.8 1	1 mm	yellow	422325	D
		Angled 15°		TLA Xi 3.8 2	2 mm	yellow	422326	D
				TLA Xi 3.8 3	3 mm	yellow	422327	D
				TLA Xi 3.8 5	5 mm	yellow	422328	D
				TLA Xi 4.5 1	1 mm	blue	422329	D
				TLA Xi 4.5 2	2 mm	blue	422330	D
				TLA Xi 4.5 3	3 mm	blue	422331	D
	TLA 15 Xi 3.4 1		1 mm	silver	422332	F		
	TLA 15 Xi 3.4 2		2 mm	silver	422333	F		
	TLA 15 Xi 3.4 3		3 mm	silver	422334	F		
Angled 25°		SF 2302	TLA 15 Xi 3.8 1	1 mm	yellow	422335	F	
			TLA 15 Xi 3.8 2	2 mm	yellow	422336	F	
			TLA 15 Xi 3.8 4	4 mm	yellow	422337	F	
			TLA 15 Xi 4.5 1	1 mm	blue	422338	F	
			TLA 15 Xi 4.5 2	2 mm	blue	422339	F	
			TLA 15 Xi 4.5 4	4 mm	blue	422340	F	
Angled 25°		SF 2409	TLA 25 Xi 3.4 1	1 mm	silver	422460	F	
			TLA 25 Xi 3.4 2	2 mm	silver	422461	F	
			TLA 25 Xi 3.4 3	3 mm	silver	422462	F	
			TLA 25 Xi 3.8 1	1 mm	yellow	422463	F	
			TLA 25 Xi 3.8 2	2 mm	yellow	422464	F	
			TLA 25 Xi 3.8 3	3 mm	yellow	422469	F	
			TLA 25 Xi 3.8 4	4 mm	yellow	422465	F	
			TLA 25 Xi 4.5 1	1 mm	blue	422466	F	
			TLA 25 Xi 4.5 2	2 mm	blue	422467	F	
			TLA 25 Xi 4.5 4	4 mm	blue	422468	F	
		Castable abutment, plastic		PA U	418181	A		

Tightening torque for Xi 3.0 = 13 Ncm, tighten with **HT 0.9**

Tightening torque for Xi 3.4, 3.8, 4.5 = 20 Ncm, tighten with **HT 1.25**



## IMPRESSION TAKING AND LABORATORY ACCESSORIES FOR CEMENTED PROSTHETICS

	Description	Code	REF	Price cat.
	Impression post with with top screw for manual operation, short For closed impression taking	TS Xi 3.0 S	422345	C
		TS Xi 3.4 S	422346	C
		TS Xi 3.8 S	422347	C
		TS Xi 4.5 S	422348	C
	Impression post with long screw For open impression taking	HLT Xi 3.0 *	422349	C
		HLT Xi 3.4	422350	C
		HLT Xi 3.8	422351	C
		HLT Xi 4.5	422352	C
	Implant analogue with internal hexagon	IA Xi 3.0	422353	B
		IA Xi 3.4	422354	B
	IA Xi 3.8	422355	B	
	IA Xi 4.5	422356	B	

\* Tighten with **HT 0.9**, all others must be tightened with **HT 1.25**

## ABUTMENTS FOR SCREW RETAINED PROSTHETICS

	Description	Code	REF	Price cat.
	Abutment for Xi 3.4, silver 2 mm gingival height Two-part, with screw	OSA Xi 3.4 2	422361	E
	Abutment for Xi 3.8, yellow, 2 mm gingival height Two-part, with screw	OSA Xi 3.8 2	422362	E
	Abutment for Xi 3.8, yellow, 4 mm gingival height Two-part, with screw	OSA Xi 3.8 4	422363	E
	Abutment for Xi 4.5, blue, 2 mm gingival height Two-part, with screw	OSA Xi 4.5 2	422364	E

Tighten with **HT 1.77**

## IMPRESSION TAKING AND LABORATORY ACCESSORIES FOR SCREW RETAINED PROSTHETICS

					or		
<b>Code</b>	TST STI	SF 365	OA STI	PAOA		PAOR	SF 350
<b>REF</b>	420339	420938	420340	420342		420343	420930
<b>Description</b>	Transfer post	Screw for connecting TST STI	Lab analogue for OSA	Castable abutments white, 10 mm high, Pack of 5	internally edged	Internally round	Screw for fixation
<b>Price cat.</b>	B	B	B	B		B	B

## GRINDABLE ABUTMENTS



Description	Code	REF	Price cat.
Bur cylinder for Xi 3.8 incl. screw SF 2301	FZ Xi 3.8	422367	D

Bur cylinder 20° for Xi 3.8 incl. screw SF 2301	FZ20 Xi 3.8	422369	D
---	-------------	--------	---

Tighten with **HT 1.25**

## LOCALICER®



Description	Height	Code	REF	Price cat.
Localicer® for Xi 3.4	2 mm	LOC Xi 3.4 2	422372	D

Localicer® for Xi 3.4	3 mm	LOC Xi 3.4 3	422373	D
-----------------------	------	--------------	--------	---

Localicer® for Xi 3.4	4 mm	LOC Xi 3.4 4	422374	D
-----------------------	------	--------------	--------	---



Localicer® for Xi 3.8	2 mm	LOC Xi 3.8 2	422375	D
-----------------------	------	--------------	--------	---

Localicer® for Xi 3.8	3 mm	LOC Xi 3.8 3	422376	D
-----------------------	------	--------------	--------	---

Localicer® for Xi 3.8	4 mm	LOC Xi 3.8 4	422377	D
-----------------------	------	--------------	--------	---



Localicer® for Xi 4.5	2 mm	LOC Xi 4.5 2	422378	D
-----------------------	------	--------------	--------	---

Localicer® for Xi 4.5	3 mm	LOC Xi 4.5 3	422379	D
-----------------------	------	--------------	--------	---

Localicer® for Xi 4.5	4 mm	LOC Xi 4.5 4	422380	D
-----------------------	------	--------------	--------	---

When using LOC-abutments and KOS LOC, we recommend to use minimally six implants per jaw and to use a single denture as splinting. Tighten with **HT 1.77**.

## ACCESSORIES FOR LOCALICER®



Description	Code	REF	Price cat.
Analogue + impression set	AA LOC	462337	C



Set with 5 caps + 1 housing (EXTERNAL PRODUCT)	NCS	462338	D
--	-----	--------	---

**Pull-off force**  
 Yellow 600 g, Pink 1.200 g, Transparent 1.800 g, Violet 2.700 g  
 Black has no retention and is designed for temporary solutions for up to one month

## BALLHEAD ABUTMENTS



Description	Code	REF	Price cat.
Ball abutment for Xi 3.0 head Ø 2.5 mm; 2 mm height	TB Xi 3.0 2	422381	E
Ball abutment for Xi 3.0 head Ø 2.5 mm; 4 mm height	TB Xi 3.0 4	422382	E
Ball abutment for Xi 3.4 head Ø 2.5 mm; 2 mm height	TB Xi 3.4 2	422383	E
Ball abutment for Xi 3.4 head Ø 2.5 mm; 4 mm height	TB Xi 3.4 4	422384	E
Ball abutment for Xi 3.8 head Ø 2.5 mm; 2 mm height	TB Xi 3.8 2	422385	E
Ball abutment for Xi 3.8 head Ø 2.5 mm; 4 mm height	TB Xi 3.8 4	422386	E
Ball abutment for Xi 4.5 head Ø 2.5 mm; 2 mm height	TB Xi 4.5 2	422387	E
Ball abutment for Xi 4.5 head Ø 2.5 mm; 4 mm height	TB Xi 4.5 4	422388	E

Tighten with **HAS 2** or **Tool E** (REF 462377)

## ACCESSORIES FOR BALLHEAD ABUTMENTS



Description	Unit	Code	REF	Price cat.
Nylon cap transparent, Pull-off force ca. 1200g (EXTERNAL PRODUCT)	Pack of 2	NC	465028	A1
Nylon cap pink, Pull-off force ca. 800g (EXTERNAL PRODUCT)	Pack of 2	NC 1	465029	A1
Nylon cap yellow, Pull-off force ca. 500g (EXTERNAL PRODUCT)	Pack of 2	NC 2	465030	A1
Green, strong Nylon caps R-NC With increased friction strength Only with reduced diameter ball	Pack of 2	R-NC	465034	A1
Pink, medium ≤ 2.3 mm	Pack of 2	R-NC 1	465033	A1
Orange, soft (EXTERNAL PRODUCT)	Pack of 2	R-NC 2	465032	A1
Metal sleeve for all nylon caps (EXTERNAL PRODUCT)		H	465031	B

## TITANIUM BASE FOR CAD CAM



Description	Material	Code	REF	Price cat.
Titanium base for Xi 3.0, antirotation	Ti6Al4V	MB Xi 3.0	422473	D
Tighten with <b>HT 0.9</b>				
Titanium base for Xi 3.4, antirotation	Ti6Al4V	MB Xi 3.4	422470	D
Titanium base for Xi 3.8, antirotation	Ti6Al4V	MB Xi 3.8	422471	D
Titanium base for Xi 4.5, antirotation	Ti6Al4V	MB Xi 4.5	422472	D
Tighten with <b>HT 1.25</b>				

## MULTI-UNIT ABUTMENTS

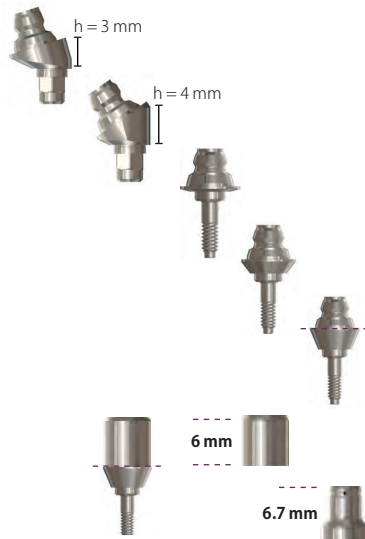

Description	Material	Code	REF	Price cat.
Abutment 17° angled Incl. screw SF 44	Ti6Al4V	MU2 17 Xi 3.8	422500	L
Abutment 35° angled Incl. screw SF 44	Ti6Al4V	MU2 35 Xi 3.8	422501	L
Abutment straight Gingiva height 0.5 mm	Ti6Al4V	MU2S 0.5 Xi 3.8	422502	G
Abutment straight Gingiva height 1.5 mm	Ti6Al4V	MU2S 1.5 Xi 3.8	422503	G
Abutment straight Gingiva height 2.5 mm	Ti6Al4V	MU2S 2.5 Xi 3.8	422504	G
Gingivaformer, incl. screw SF MU2 Height above abutment shoulder 6 mm	Ti6Al4V	GF MU2	418286	C
Localicer®, incl. screw SF MU2 Height above abutment shoulder 6.7 mm Use with NCS Set REF 462338	Ti6Al4V	MU2	418287	C

Insertion of the angled MU2 abutments with **HT 1.25**, straight MU2S abutments with **HT 1.77**

## ACCESSORIES FOR MULTI-UNIT ABUTMENTS

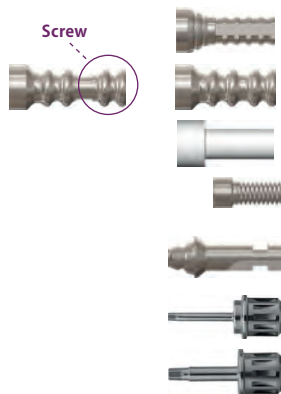

















Description	Material	Code	REF	Price cat.
Temporary base SF MU2 sold separately	Ti6Al4V	TC MU2	418290	D
Transfer straight Incl. screw SFL MU2	Ti6Al4V	TS MU2	418291	C
Castable for Multi-Unit Incl. screw		PA MU2	418292	A
Screw for TC MU	Ti6Al4V	SF MU2	418293	B
Lab analogue for Multi-Unit	Ti6Al4V	IA MU2	418295	B
Hex instrument, long		HT 1.25	425100	C
Hex instrument, long		HT 1.77	425103	C

## INSERTION TOOLS



Description	Code	REF	Price cat.
Insertion tool medium, for TempBase®	For implant ITT2 Xi 3.0 OS	422408	D
Insertion tool short, for TempBase®	For implant ITT3 Xi 3.0 OS	422409	D
Insertion tool long	For implant IT1 Xi 3.4 OS	422410	D
Insertion tool medium	For implant IT2 Xi 3.4 OS	422411	D
Insertion tool short	IT3 Xi 3.4 OS	422412	D
Insertion tool long, 36 mm	For implant IT1 Xi U OS	422413	D
Insertion tool medium, 26 mm	For implant IT2 Xi U OS	422414	D
Insertion tool short, 18 mm	For implant IT3 Xi U OS	422415	D

## TOOLS

	Description	Code	REF	Price cat.
	Universal ratchet adapter for all contra-angle instruments, for TW2 and RAT 2. Max. 30 Ncm	UAW	425107	E
	Do not use UAW with RAT 2 and Heatless® drills. The max. torque for Heatless® drills is 35 Ncm. UAW may only be used with torque wrench TW2.			
	Parallel depth gage brown	PDG 3.0	422416	B
	Parallel depth gage silver	PDG 3.4	422417	B
	Parallel depth gage yellow	PDG 3.8	422418	B
	Parallel depth gage blue	PDG 4.5	422419	B
	Standardized X-ray measuring probe. Scaling 1 mm, X-ray measuring for cylindrical implant types	PDG	425400	A
	Hex instrument Ø 1.25 mm	HT 1.25	425100	C
	Hex instrument for contra-angle	HT 1.25 M	425112	C
	Hex instrument, extralong Length 45 mm, Ø 1.25 mm	HTX 1.25	425102	C
	Hex instrument 1.25 For contra-angle, 45 mm	HTW 1.25	425111	C
	Hex instrument Ø 1.77 mm	HT 1.77	425103	C
	Hex instrument for contra-angle	HT 1.77 M	425113	C
	Hex instrument for contra-angle, extralong	HTX 1.77	425104	C
	Hex instrument for 0.9 mm screws	HT 0.9	422428	C
	Hex instrument for contra-angle	HT 0.9 M	425114	C
	Drill extension contra-angle (DX2) Extends by 19 mm	DX 2	500704	D
	Flat spanner For TB Xi ballhead abutments	HAS 2	463109	H
	Tool E, 20 mm long	Tool E	462377	D
	Torque wrench, 10 - 70 Ncm	TW2	425402	S

We recommend to have our torque wrench calibrated annually.

## GUIDE JACKET

**Description**

BFH 2.0 guide jacket 2.0 mmd

**Unit**

Pack of 5

**Material**

Ti6Al4V

**REF**

425410

**Price cat.**

B



BFH 2.5 guide jacket 2.5 mmd

Pack of 5

Ti6Al4V

425411

B



BFH 3.0 guide jacket 3.0 mmd

Pack of 5

Ti6Al4V

425412

B



BFH 3.2 guide jacket 3.2 mmd

Pack of 5

Ti6Al4V

425413

B



BFH 3.5 guide jacket 3.5 mmd

Pack of 5

Ti6Al4V

425414

B

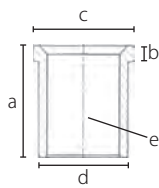

a) Length

5 mm

b) Height of step

0.7 mm

c) Max. Ø top

3.7 - 5 mm

d) Nominal Ø

3 - 4.4 mm

e) Ø of drilling in the drill template

2.05 - 3.55 mm



Model with residual teeth for the fabrication of a drill guide for creating cavities for fixing the later drill guide for implant cavities.













Drill guide for creating cavities for later fixation of the surgical drill guide.



Surgical drill guide for safe BCS® placement. The drill sleeves are designed for 2.0 mm Twist drills.

## HEATLESS® DRILL DFN / DFLN FOR IMPLANTS WITH CONICAL CORE

	Description	Ø working space	Max. working length	Overall length	REF	Price cat.
 7 11 15 19 23 9 13 17 21	<b>Pilot drill</b>					
	DS 2	2.0 mm	17 mm	32.5 mm	425001	D
	DS 2.8	2.8 mm	15 mm	32 mm	425005	D
	DSL 2	2.0 mm	23 mm	41 mm	425002	D
   	<b>Form drill</b>					
	DFN 3.0	2.7 mm	18 mm	36 mm	425030	E
	DFN 3.4	3.0 mm	18 mm	36 mm	425031	E
	DFN 3.7	3.4 mm	18 mm	36 mm	425032	E
	DFN 4.2 - 4.5	4.05 mm	18 mm	36 mm	425033	E
	DFN 5.5	4.4 mm	18 mm	36 mm	425034	E
   	<b>Form drill long</b>					
	DFLN 3.0	2.7 mm	18 mm	39 mm	425035	E
	DFLN 3.4	3.0 mm	18 mm	39 mm	425036	E
	DFLN 3.7	3.4 mm	18 mm	39 mm	425037	E
	DFLN 4.2 - 4.5	4.05 mm	18 mm	39 mm	425038	E
   	<b>Corticalis drills (use alternatively to bone tap)</b>					
	C Drill Xi 3.0	3.0 mm	5 mm	27 mm	425041	D
	C Drill 3.4	3.2 mm	5 mm	27 mm	425042	D
	C Drill 3.7	max. 3.8 mm	max. 5 mm	27 mm	425043	D
	C Drill 4.2 - 4.5	max. 4.6 mm	max. 5 mm	27 mm	425044	D

The actual drill diameter is smaller than the implant diameter.

**\* IT HAS BEEN SCIENTIFICALLY PROVEN**

Heatless® drills by Dr. Ihde Dental generate 55% less heat than traditional bone drills from other manufacturers. This makes it possible to use higher rotational speeds: between 3,000 and 5,000 rpm are recommended with good external cooling and intermittent drill technique.

CORTICAL TAP FOR 1<sup>ST</sup> CORTICALIS, WITHOUT HEX

	Description	Code	REF	Price cat.
 10.2 mm	Cortical tap	KGS Xi 3.0 OS	422424	D
	Cortical tap	KGS Xi 3.4 OS	422425	D
	Cortical tap	KGS Xi 3.8 OS	422426	D
	Cortical tap	KGS Xi 4.5 OS	422427	D
		For the cap use in hard cortical bone only		

## DRILLSTOP TRAY

Not suitable for dry heat sterilizers



Description	Code	REF	Price €
Drillstop A		500881	
Drillstop C		500883	
Drillstop D		500884	
Drillstop E		500885	
Drillstop G		500887	
Drillstop I		500889	
Drillstop J		500890	
Drillstop K		500891	
Drillstop L		500892	
Form drill	DFN 3.0	425030	
Form drill	DFN 3.4	425031	
Form drill	DFN 3.7	425032	
Form drill	DFN 4.2-4.5	425033	
Form drill	DFN 5.5	425034	
Form drill	DFLN 3.0	425035	
Form drill	DFLN 3.4	425036	
Form drill	DFLN 3.7	425037	
Form drill	DFLN 4.2 - 4.5	425038	
<b>Tray with content</b>		60031-K	739.00

## STARTER TRAY

Autoclavable up to 134° C, not suitable for dry heat sterilizers.

This surgical kit contains all drills and tools for first works with the Xign® system.

Material: autoclavable plastic



Description	Code	REF	Price €
Insertion tool medium	ITT2 Xi 3.0 OS	422408	
Insertion tool medium	IT2 Xi 3.4 OS	422411	
Insertion tool	IT2 Xi U OS	422414	
Hex instrument	HT 0.9	422428	
Hex instrument long	HT 1.25	425100	
Spiral drill DS 2	DS 2.0	425001	
Form drill DFN 3.0	DFN 3.0	425030	
Form drill DFN 3.4	DFN 3.4	425031	
Form drill DFN 3.7	DFN 3.7	425032	
Form drill DFN 4.2-4.5	DFN 4.2-4.5	425033	
Standardized X-ray measuring probe	PDG	425400	
Torque wrench	TW2	425402	
<b>Tray with content*</b>		S60044-K	upon request

\*empty tray upon request







# IHDE DENTAL

(The products of this catalogue are CE marked (class I) and CE 1936 marked (class IIa and IIb) according to 93/42/EC Directive).

Commercial products that are not monitored by our notified body are declared as third-party products.

We are certified DIN EN ISO 13485, and annex II of EEC Directive 93/42 EWG (2007).

Due to technical reasons the product dimensions shown in this brochure might deviate from reality.

Xign® implants are patent-protected. Xign® is a registered trademark.

In case that implants would be reprocessed (cleaned, resterilized) infections could occur, because no validated procedures for reprocessing are available.

## Compilation and clarification of symbols on the pack:



Batch No.



Sterilized by gamma radiation



Non-sterile



Intended for use by dentists or surgeons only



Single use product



Instruction for use



Expiry date



Store in a dry place



Store tightly keep closed



Do not use if packing is damaged



Do not resterilize



Manufacturer



Production date



Catalogue number



Anti-rotation through precision internal hexagon & two telescoping areas

Excellent stability in all bone qualities

Universal application for permanent and removable prosthodontics

Endosseous surface ultra-rough

**IHDE**DENTAL 

**Dr. Ihde Dental AG**  
Dorfplatz 11  
CH - 8737 Gommiswald / SG  
Tel +41 (0)55 293 23 23  
contact@implant.com  
www.implant.com

**Dr. Ihde Dental GmbH**  
Erfurter Str. 19  
D - 85386 Eching / Munich  
Tel +49 (0)89 319 761 0  
Fax +49 (0)89 319 761 33  
info@ihde-dental.de  
www.ihde-dental.de

REF 6645\_XIGN\_EN\_20210420\_V028