

TWO PIECE IMPLANTS

DENTAL IMPLANT
SYSTEM

BoneLevelPlus[®]



"FOR ME, IMPLANTOLOGY BEGINS
WHERE OTHERS HAVE GIVEN UP."

- Dr. Stefan Ihde



Dr. Ihde Dental has been a reliable partner for over 60 years providing a wide range of implant systems and consumables. We supply dentists and dental technicians with precisely coordinated materials and systems, which are easy and reliable to use. We always ensure high quality and an excellent price-performance ratio so that you can guarantee allround treatment for your patients that is cost-effective and highly efficient. The following catalog gives you an overview and all the essential information about our implant systems. You can also contact us personally any time using the phone numbers provided. Further information can be found on our websites:

www.implant.com || www.ihde-dental.de || www.ihde.com

The company was founded in 1954 in Berlin by the dental technician Klaus Ihde. The company relocated to Bavaria in the 1960s. At the end of the 1980s, Dr. Ihde Dental GmbH (Germany) and Dr. Ihde Dental AG (Switzerland) were formed from the Klaus Ihde retail company. Ihde Dental is now represented in four locations in Europe and over 45 countries. The company group is one of the most innovative implant companies in the world – based on new developments and patents issued or pending.

The core activities of Ihde Dental are the development, procurement and distribution of medical products. We use a large number of suppliers in consumables, but we have produced implants in our own factory for many years. All components are manufactured quickly, precisely and economically thanks to state-of-the-art production technology and well-equipped machinery.

Our partners

Users and customers provide us with many new ideas and excellent suggestions. Collaboration with our customers is extremely important to us. Contact us at any time if you have any improvements or questions. Your ideas and opinions help us all to meet the daily wishes of patients to a greater and better extent. We also put the needs of the patient first..

Our market performance and work ethic

Since it was founded, the company has focused on innovative ideas and advanced technology, premium quality, an excellent price-performance ratio, optimal patient and user friendly products and durability. Our range combines the latest findings from research and practices in many countries around the world.

Customer orientated to us means – **available for you!**

- We provide training courses, refresher courses and user advice.
- We provide customers with comprehensive and technically sound advice.
- We also visit you in your practice upon request.

**Please call us to arrange an appointment
or send us an email.**

IHDEDENTAL 

Dr. Ihde Dental AG
Dorfplatz 11
CH - 8737 Gommiswald / SG
Tel. +41 (0)55 293 23 23
contact@implant.com

Dr. Ihde Dental GmbH
Erfurter Str. 19
D - 85386 Eching / Munich
Tel. +49 (0)89 319 761-0
Fax +49 (0)89 319 761-33
info@ihde-dental.de

THE ADVANTAGES

OF THE ENDOSSEOUS DENTAL IMPLANT SYSTEM **BLP®**

The surface of **Bone Level Plus®** implants provide a specially lasered surface with exactly defined properties. For anti-rotation an internal square connects with press-fit to the abutment. The cone in combination with the internal stare provides stability and 100% tightness. **Bone Level Plus®** implants are universally applicable for fixed and removable prosthetics.

The prescribed or recommended tightening torques for implants, abutments and screws can be found on our website:

www.implant.com/en/downloads

Safely
antirotational thanks
to its internal
precision square

Cone technology
for a tight seal

Universally
suitable for fixed
and removable
prosthodontics

Made of highly
resistant
titanium alloy

Smart
instrument tray

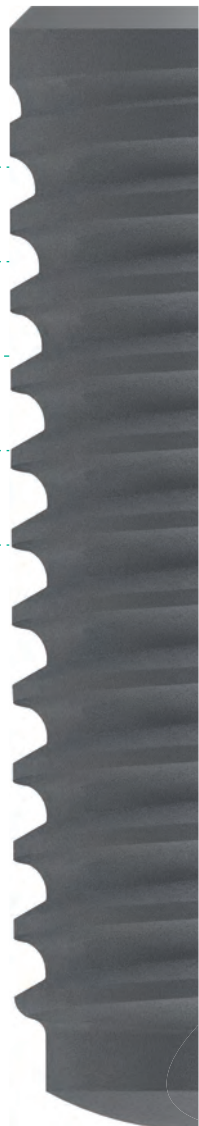

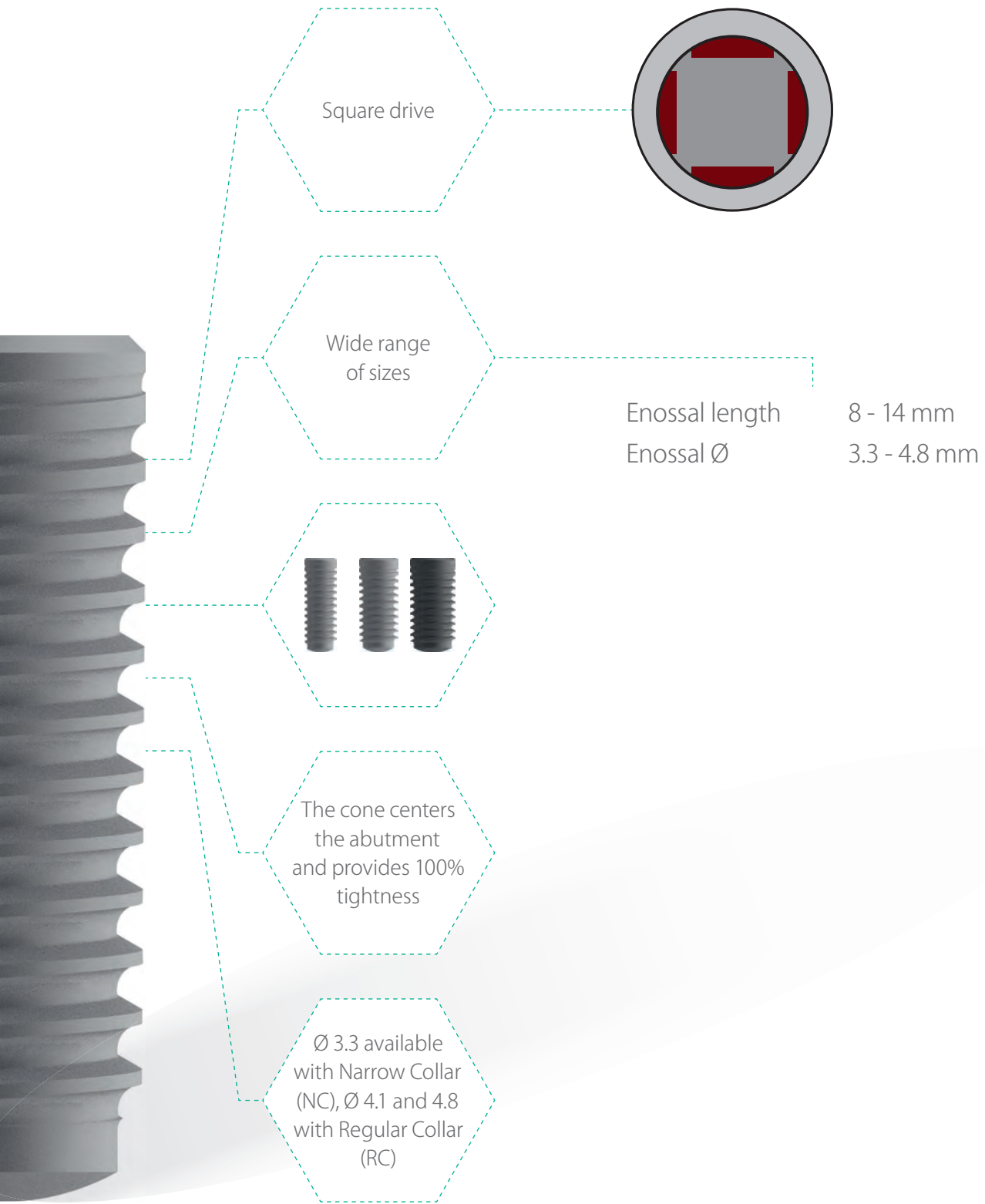

PREPARATORY STEPS WHEN USING A DRILLING TEMPLATE

1. Have your laboratory produce a drilling template with the appropriate drill holes for the marker bore. To be on the safe side, the laboratory might insert guide sleeves (**REF BFH**) into the drill holes to ensure that the drilling angle is correct. Use a 2 mm \varnothing drill for pilot drilling.
2. For subsequent drilling sequences, drill stops can be used that are slid over the drill according to the appropriate depth of the drill hole and screwed in place. Consider the thickness of the mucosa and the height of the template as appropriate.

Thanks to the extremely high cutting efficiency of our drills, no ascending drilling sequences will usually be required.

Recommended RPM: 2000-5000

Apply sufficient cooling and allow the cooling to reach the working blades of the drills. Drill stop taking from $\varnothing 2.8$.

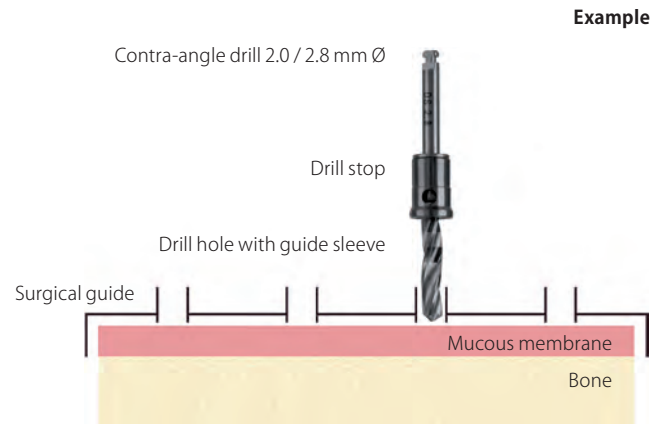

SURGERY

1. Recommended drill sequence

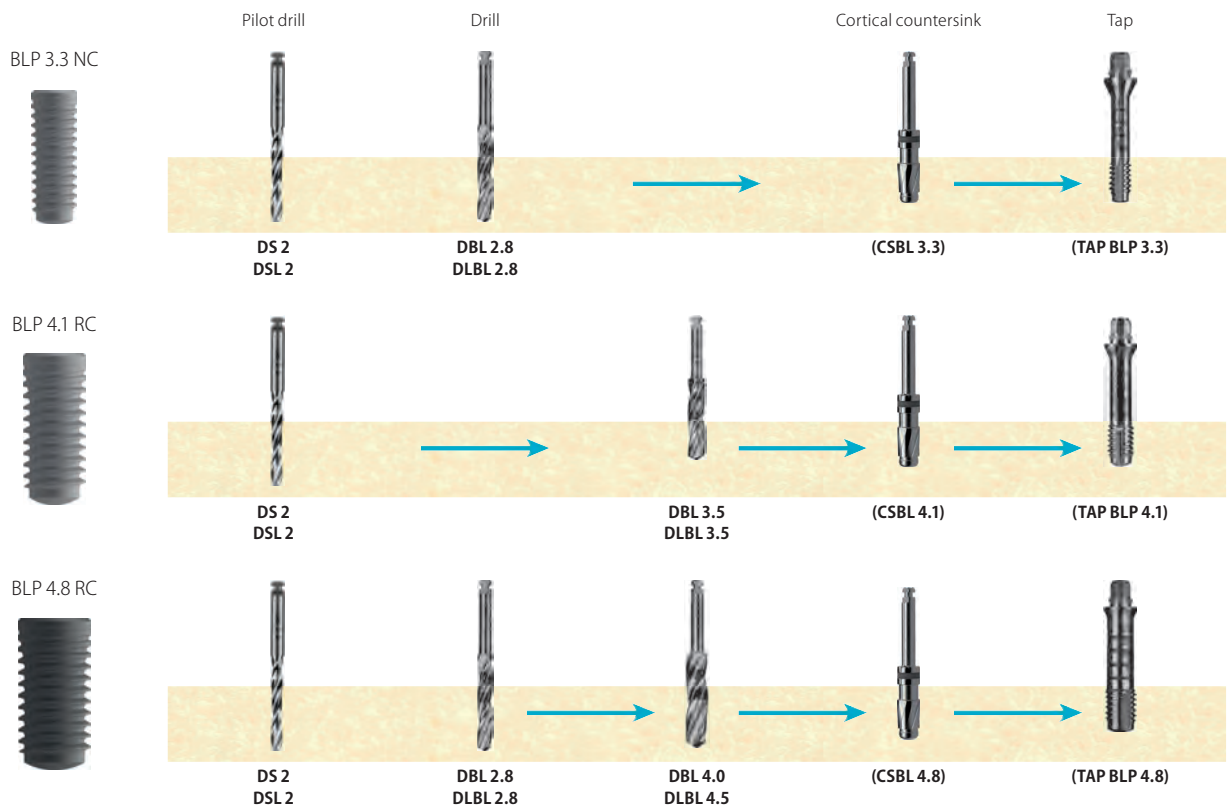

Owing to the high quality and geometry of the blades of our drills, the final preparation may be performed immediately after the pilot drilling.

2. Implant packaging



Original packaging



Open the sealed cover at the lid. Remove the label and place it into the patients record.

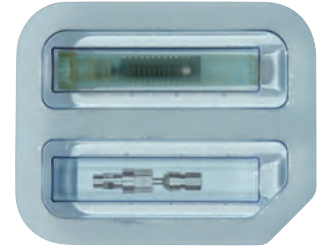

The open pack contains the implant in a sterile tube (primary packaging).

3. Remove the implant from its packaging

1. Open the Lid
2. The implant is attached to the cap and can be removed by breaking it off at the pre-determined breaking point
3. Remove the implant, making sure not to touch the inner wall of the tube

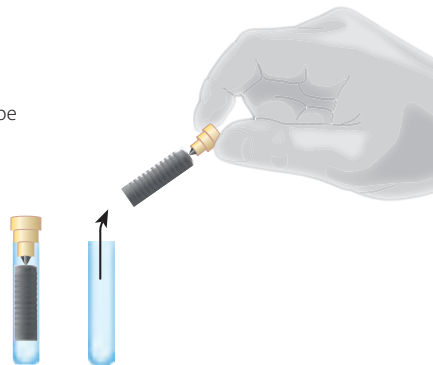

4. Handling

4.1 Connect

Attach the placement aid to the implant, holding the cap to which the implant is attached with the other hand.

4.2 Mounting the adapter ITV WST / contra-angle

Place the ITV Wst (angled handpiece) or ITV (ratchet) adapter on the ITV BLP placement aid. Mount the placement aid. Hold the cap firmly in one hand and break off the implant at the pre-determined breaking line.

Insertion tool ITV BLP
Bone Level Plus® implant
Pre-determined break line
Lid with implant holder

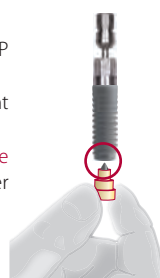

Insertion tool ITV BLP
Pre-determined break line
Lid

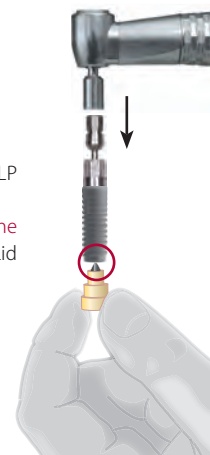

4.3 Alternative to 4.2:

Place the IT ITV (ratchet) adapter on the ITV BLP placement aid.

Mount the placement aid. Hold the cap firmly in one hand and break off the implant at the pre-determined breaking line.



6. Remove insertion tool from implant

Loosen the insertion aid from the implant by pulling it off.

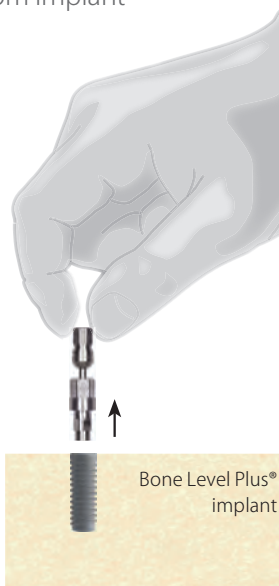

5. Insertion

Use the angled handpiece, ratchet or shank to screw the implant into the implant bed (clockwise).

The enossal aspect of the implant must be submerged in the bone. Upon **complete** insertion, the implant may be turned back ¼ revolution to reduce the load on the bone.

The system is suitable for deep insertion (below bone level).

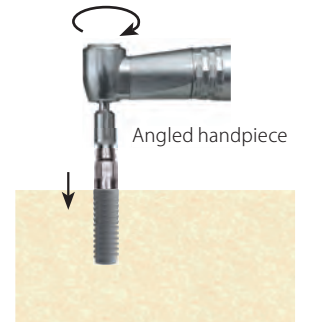

7. Result



8. Aftercare

Seal the implant with a matching cover screw.

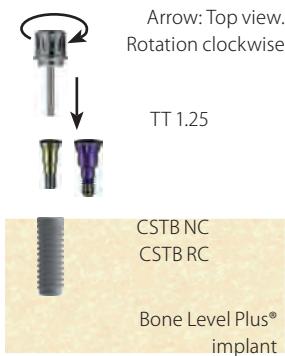

After healing time: Remove surgical screw.

Arrow: Top view. Rotation counter clockwise.

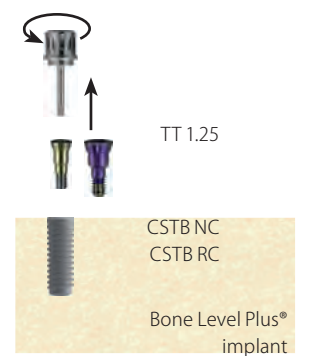

9. Pick-up impressions

9.1 Impression with perforated custom tray

Torx-instrument TT 1.25

Insert impression posts
HLT BLP NC/RC

Bone Level Plus® implant

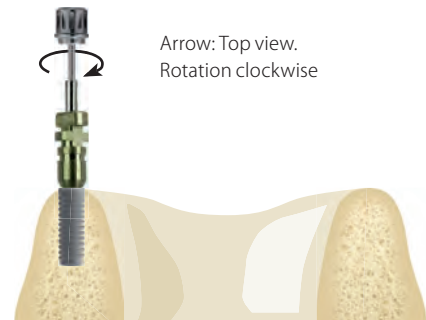

9.2 Before taking the impression

Take an impression in an A silicone. You can use the open-tray or the closed-tray technique.

It is necessary to remove the HLT BLP NC/RC impression post from the implant to be able to take out the impression tray.

Impression post HLT BLP NC/RC

Bone Level Plus® implant

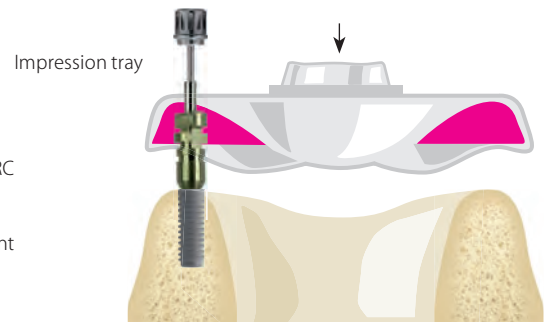

9.3 Taking the impression

Detach the HLT BLP NC/RC from the implant. HLT BLP NC/RC will stay within the impression.

Use TT 1.25 to loosen screw

Relief window in the
impression tray

HLT BLP NC/RC

Bone Level Plus® implant

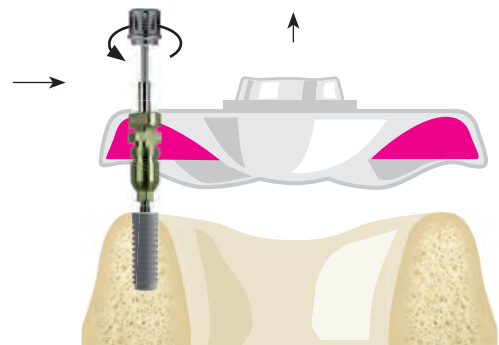

9.4

View of the impression post in the impression (pick-up technique, bottom view).

Position of the Impression post

Impression material

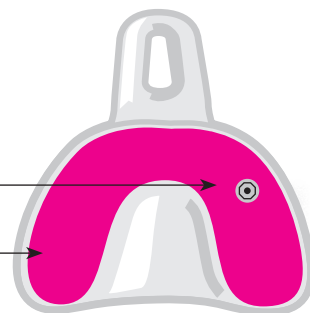

9.5

Once the impression has been taken, the implant is closed with a healing abutment, while the impression is sent to the laboratory.

TT 1.25

Surgical screw CSTB NC/RC

Bone Level Plus® implant

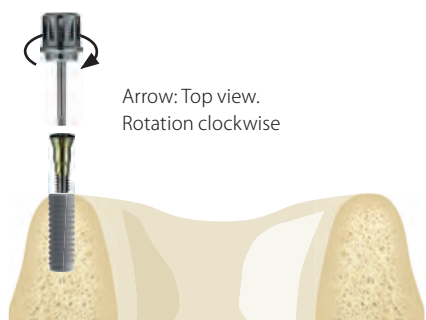

10. Closed tray impression taking

10.1 Impression with closed tray

Impression with custom tray.

Securing the impression post with the thumbscrew

TS BLP NC/RC

Bone Level Plus® implant

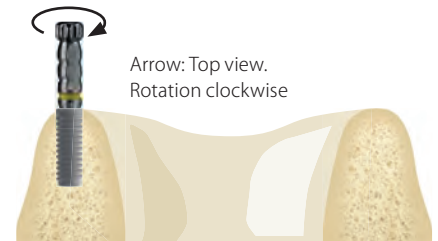

10.2 Before taking the impression

Take an impression in an A silicone.
You can use the open-tray or the closed-tray technique.

With the closed impression technique, the TS BLP NC/RC will always remain on the implant when removing the impression.

Impression tray

Impression post
TS BLP NC/RC

Bone Level Plus® implant

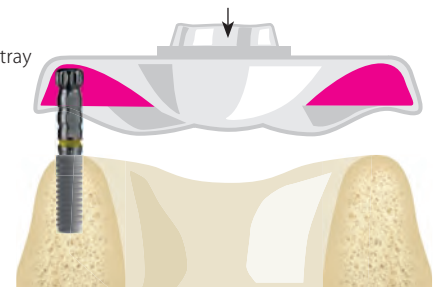

10.3 Removing the impression

In the case of closed impressions, the TS BLP NC/RC impression post will remain on the implant after removing the impression tray.

The impression post will be removed afterwards.

Impression post
TS BLP NC/RC

Bone Level Plus® implant

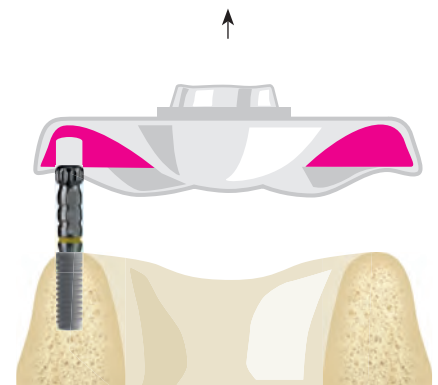

10.4

Once the impression has been taken, the implant is closed with an HA NC/RC healing abutment, while the impression is sent to the laboratory.

TT 1.25

insert surgical screw
CSTB NC/RC

Bone Level Plus® implant

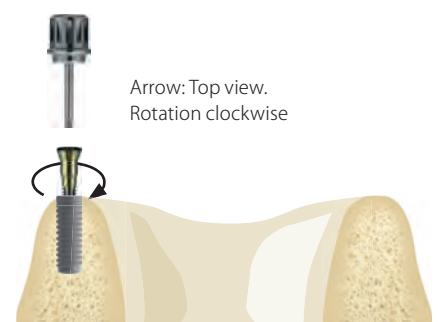

11. Procedures in the laboratory

11.1 Pick-up technique

Tighten the IAB against the HLT BLP (NC/RC) impression post.

Use the TT 1.25 to insert the lab analogue

HLT BLP NC/RC

IAB NC or IAB RC

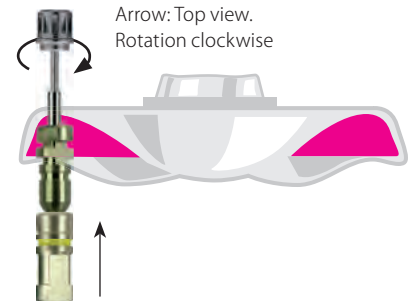

11.2 Closed technique

Secure the IAB NC/RC against the TS BLP (NC or RC) **A**

Reposition the impression post inside the impression **B**

Pour the impression.

Use the thumbscrew to tighten the impression post on the lab analogue.

TS BLP NC/RC

IAB NC or IAB RC

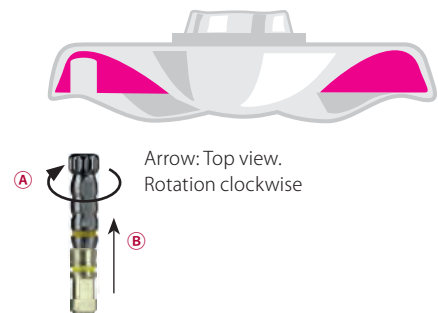

11.3

Pour the impression in dental stone, then remove the impression posts from the lab analogues.

Lab analogue

Fill with gypsum

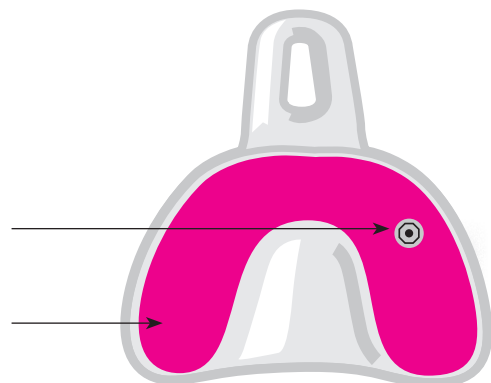

11.4

The lab analogue will now be embedded in the gypsum in the correct position.

IAB NC/RC



11.5

Positioning of the screw-retained TLA2 15 BLP RC abutment, determining its optimal position and correct angulation.

NOTE The square end must be inserted completely into the analogue.

TT 1.25

Insert screw

TLA2 15 BLP NC/RC
Watch out for the correct square end position



IAB NC/RC

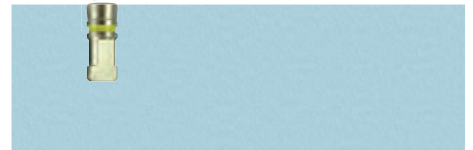

11.6

The correct position of the abutment must be ensured during transfer to the mouth.

TLA2 15 BLP NC/RC



11.7

If multiple angled abutments are used, the laboratory will produce a removable resin splint (e.g. from pattern resin) to facilitate positioning within the mouth.

TLA2 15 BLP RC

Pattern Resin

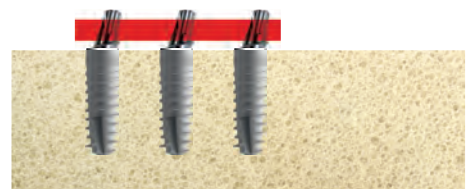

BONE LEVEL PLUS® IMPLANTS

With No-Itis® Laser Surface.
The implant body is made of Ti6Al4V.

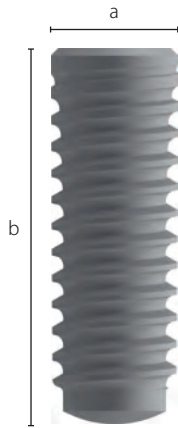

a) Enossal Ø	3.3 - 4.8 mm
b) Enossal length	8 - 14 mm
NC	Narrow Collar
RC	Regular Collar

Description	Enossal Ø	Enossal length	REF	Price cat.
BLP 3.3 8 NC	3.3 mm	8 mm	900500	H
BLP 3.3 10 NC	3.3 mm	10 mm	900501	H
BLP 3.3 12 NC	3.3 mm	12 mm	900502	H
BLP 3.3 14 NC	3.3 mm	14 mm	900503	H
BLP 4.1 8 RC	4.1 mm	8 mm	900504	H
BLP 4.1 10 RC	4.1 mm	10 mm	900505	H
BLP 4.1 12 RC	4.1 mm	12 mm	900506	H
BLP 4.1 14 RC	4.1 mm	14 mm	900507	H
BLP 4.8 8 RC	4.8 mm	8 mm	900508	H
BLP 4.8 10 RC	4.8 mm	10 mm	900509	H
BLP 4.8 12 RC	4.8 mm	12 mm	900510	H
BLP 4.8 14 RC	4.8 mm	14 mm	900511	H

Min. Insertion torque 35 Ncm

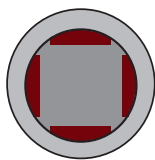

Square drive

Delivery inclusive insertion tool ITV BLP and surgical screw REF 900518 or 900519



- Safely anti-rotational thanks to its internal precision square
- Cone technology for a tight seal
- Universally suitable for fixed and removable prosthodontics
- The cone centers the abutment and provides 100% tightness

SURGICAL SCREWS



Description	Code	REF	Price cat.
Surgical screw for BLP 3.3	CSTB NC	900518	B
Surgical screw for BLP 4.1 and 4.8	CSTB RC	900519	B

GINGIVAFORMER

**Description**

Gingivaformer	conical
Gingivaformer	conical
Gingivaformer	conical
Gingivaformer	conical
Gingivaformer	conical
Gingivaformer	conical
Gingivaformer	conical
Gingivaformer	bottle shape
Gingivaformer	bottle shape
Gingivaformer	bottle shape
Gingivaformer	bottle shape

Code**REF****Price cat.**

GF NC 3.6 2	900590	B
GF NC 3.6 3.5	900591	B
GF NC 4.8 3.5	900594	B
GF RC 4.5 2	900596	B
GF RC 4.5 4	900597	B
GF RC 4.5 6	900598	B
GF RC 6 2	900599	B
GF B NC 3.3 3.5	900602	B
GF B NC 3.3 5	900603	B
GF B RC 4.4 4	900604	B
GF B RC 4.7 6	900605	B

BUR CYLINDER

**Description**

Bur cylinder for BLP 3.3 for telescope crowns
Bur cylinder for BLP 4.1 and 4.8 for telescope crowns

Code**REF****Price cat.**

FZB NC	900524	D
FZB RC	900527	D

Recommended insertion torque **30 Ncm**

ANALOGUES

**Description**

Implant analogue for BLP 3.3
Implant analogue for BLP 4.1 and 4.8

Code**REF****Price cat.**

IA BLP NC	900525	B
IA BLP RC	900526	B

STANDARD ABUTMENTS

**Description**

Abutment for cementing on BLP 3.3, step 1 mm high
Height above step 4 mm, incl. screw SFBC NC

Code

CAB 1 NC

REF

900554

Price cat.

E

Abutment for cementing on BLP 3.3, step 3 mm high
Height above step 4 mm, incl. screw SFBC NC

CAB 3 NC

900555

E

Abutment for cementing on BLP 4.1 and 4.8, step 1 mm high
Height above step 5.5 mm, incl. screw SFBC RC

CAB 1 RC

900551

E

Abutment for cementing on BLP 4.1 and 4.8, step 3 mm high
Height above step 5.5 mm, incl. screw SFBC RC

CAB 3 RC

900552

E

Recommended insertion torque **20 Ncm**

SCREW-RETAINED ABUTMENTS (REDUCIBLE, GRINDABLE)

**Description**

Abutment
Incl. screw SF B

Code

TAB BLP NC/RC

REF

900521

Price cat.

D

Abutment for BLP 3.3, 15° angled
Anti-rotational, incl. screw SFB NC

TLA2 15 BLP NC

900528

F

Abutment for BLP 4.1 and 4.8, 15° angled
Anti-rotational, incl. screw SFB RC

TLA2 15 BLP RC

900523

F

Recommended insertion torque **20 Ncm**

ANATOMICAL ABUTMENTS

**Description**

Anatomical abutment for BLP 3.3
Anti-rotational, incl. screw SFB NC

Code

ANAB NC

REF

900544

Price cat.

F

Anatomical abutment for BLP 4.1 and 4.8
Anti-rotational, incl. screw SFB RC

ANAB RC

900543

F

Recommended insertion torque **20 Ncm**

TITANIUM BASE FOR CAD CAM



Description

Titanium base for BLP 3.3, anti-rotation
Incl. screw SFB NC

Code

MB BLP NC

REF

900560

Price cat.

D

Titanium base for BLP 4.1 and 4.8, anti-rotation
Incl. screw SFB RC

MB BLP RC

900562

D

CASTABLE ABUTMENTS



Description

Castable abutment for BLP 3.3
Incl. metal base and screw

Material

CoCrMo/plastic

Code

PLAB2 BLP NC

REF

900621

Price cat.

G

Castable abutment for BLP 4.1 and 4.8
Incl. metal base and screw

CoCrMo/plastic

PLAB2 BLP RC

900623

G

PICK-UP IMPRESSION POST FOR PICK-UP IMPRESSIONS



Description

Impression post for BLP 3.3

Code

HLT BLP NC

REF

900584

Price cat.

C

Impression post for BLP 4.1 and 4.8

HLT BLP RC

900585

C

IMPRESSION POST FOR CONVENTIONAL IMPRESSIONS



Description

Impression post for BLP 3.3

Code

TS BLP NC

REF

900586

Price cat.

C

Impression post for BLP 4.1 and 4.8

TS BLP RC

900587

C

Impression post long for BLP 3.3

TSL BLP NC

900588

C

Impression post long for BLP 4.1 and 4.8

TSL BLP RC

900589

C

ABUTMENTS FOR SCREW-ON PROSTHETIC

	Description	Code	REF	Price cat.
	Gingiva height 0.5 mm	TCT BLP NC 0.5	900635	D
	Gingiva height 1.5 mm	TCT BLP NC 1.5	900636	D
	Gingiva height 3.5 mm	TCT BLP NC 3.5	900637	D
	Gingiva height 0.5 mm	TCT BLP RC 0.5	900632	D
	Gingiva height 1.5 mm	TCT BLP RC 1.5	900633	D
	Gingiva height 3.5 mm	TCT BLP RC 3.5	900634	D

Tighten with **HT 1.77**

IMPRESSION TAKING AND LABORATORY ACCESSORIES

In this approach the position of the TCT hex is assigned.

	Transfer post	Long screw Tighten with HT 1.25	TCT analogue	Castable abutment 12mm high Internally round Pack of 5	Castable abutment 12mm high Internally edged Pack of 5	Fastening screw Tighten with HT 1.25
Code	TST	SFL	BTT	PSTR (grey)	PSTA	SF
REF	418147	420428	418100	418124	418123	418151
Price cat.	B	B	B	B	B	B

LOCALICER® FOR REMOVABLE PROSTHETIC

If LOC abutments are used in the upper jaw, we recommend to place at least six implants and to splint them through prosthetics in a stable manner. Tighten with **HT 1.77**.



Description	Height	Code	REF	Price cat.
Localicer® for BLP 3.3	2 mm	LOC BLP NC 2	900539	D
Localicer® for BLP 3.3	3 mm	LOC BLP NC 3	900606	D
Localicer® for BLP 3.3	4 mm	LOC BLP NC 4	900607	D
Localicer® for BLP 4.1 and 4.8	2 mm	LOC BLP RC 2	900540	D
Localicer® for BLP 4.1 and 4.8	3 mm	LOC BLP RC 3	900608	D
Localicer® for BLP 4.1 and 4.8	4 mm	LOC BLP RC 4	900609	D

ACCESSORIES FOR LOCALICER®



Description	Code	REF	Price cat.
Analogue + impression set	AA LOC	462337	C
Set with 5 caps + 1 housing (EXTERNAL PRODUCT)	NCS	462338	D

Pull-off force
 Yellow 600 g, Pink 1.200 g, Transparent 1.800 g, Violet 2.700 g
 Black has no retention and is designed for temporary solutions for up to one month





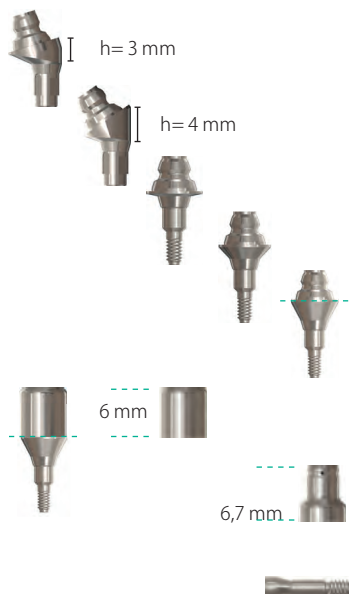

MULTI-UNIT ABUTMENTS

Insertion of the angled MU2 abutments with **HT 1.25**. Insertion of the straight MU2S abutments with **HT 1.77**













Description	Material	Code	REF	Price cat.
Abutment 17° angled Incl. screw SFB RC	Ti6Al4V	MU2 17 BLP RC	900640	L
Abutment 35° angled Incl. screw SFB RC	Ti6Al4V	MU2 35 BLP RC	900641	L
Abutment straight Gingiva height 0.5 mm	Ti6Al4V	MU2S 0.5 BLP RC	900642	G
Abutment straight Gingiva height 1.5 mm	Ti6Al4V	MU2S 1.5 BLP RC	900643	G
Abutment straight Gingiva height 2.5 mm	Ti6Al4V	MU2S 2.5 BLP RC	900644	G
Gingivaformer incl. SF MU2 Height above abutment shoulder 6 mm	Ti6Al4V	GF MU 2	418286	C
Localicer® incl. SF MU2 Height above abutment shoulder 6.7 mm Use with NCS Set REF 462338	Ti6Al4V	MU 2	418287	C
Prosthetic screw for MU2	Ti6Al4V	SFB RC	900532	B

ACCESSORIES FOR MULTI-UNIT ABUTMENTS

	Description	Material	Code	REF	Price cat.
	Temporary base SF MU2 sold separately	Ti6Al4V	TC MU2	418290	D
	Transfer straight incl. screw SFL MU2	Ti6Al4V	TS MU2	418291	C
	Castable for Multi-Unit incl. screw		PA MU2	418292	A
	Screw for TC MU2	Ti6Al4V	SF MU2	418293	B
	Lab analogue for Multi-Unit	Ti6Al4V	IA MU2	418295	B
	Hex instrument long, Ø 1.25 mm		HT 1.25	425100	C
	Hex instrument extralong, 45 mm, Ø 1.25 mm		HTX 1.25	425102	C
	Hex instrument for suprastructures, Ø 1.77 mm		HT 1.77	425103	C

INSTRUMENTS

	Description	Code	REF	Price cat.
	Pilot drill short/long 2.0 mm Ø	DS 2 / DSL 2	425001 / 425002	D
	Pilot drill short/long 2.8 mm Ø	DS 2.8 / DSL 2.8	425005 / 425006	D
	Form drill short 2.8 mm Ø	DBL 2.8	900570	E
	Form drill short 3.5 mm Ø	DBL 3.5	900571	E
	Form drill short 4.0 mm Ø	DBL 4.0	900572	E
	Cortical countersink 3.3	CSBL 3.3	900576	D
	Cortical countersink 4.1	CSBL 4.1	900577	D
	Cortical countersink 4.8	CSBL 4.8	900578	D
	Tap	TAP BLP 3.3	900579	D
	Tap	TAP BLP 4.1	900580	D
	Tap	TAP BLP 4.8	900581	D

GUIDE JACKET

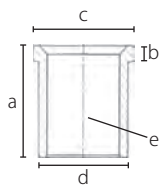
**Description**

BFH 2.0 guide jacket 2.0 mmd

Unit

Pack of 5

Material

Ti6Al4V

REF

425410

Price cat.

B

BFH 2.5 guide jacket 2.5 mmd

Pack of 5

Ti6Al4V

425411

B

BFH 3.0 guide jacket 3.0 mmd

Pack of 5

Ti6Al4V

425412

B

BFH 3.2 guide jacket 3.2 mmd

Pack of 5

Ti6Al4V

425413

B

BFH 3.5 guide jacket 3.5 mmd

Pack of 5

Ti6Al4V

425414

B

a) Length

5 mm

b) Height of step

0.7 mm

c) Max. Ø top

3.7 - 5 mm







d) Nominal Ø

3 - 4.4 mm







e) Ø of drilling in the drill template

2.05 - 3.55 mm

ADAPTER

	Description	For	Length	Code	REF	Price cat.
	Adapter short / contra-angle	ITV BLP	22 mm	ITV S WST	500851	D
	Adapter long / contra-angle	ITV BLP	32 mm	ITV L WST	500852	D
	Adapter medium / contra-angle	ITV BLP	27 mm	ITV M WST	500853	D
	Ratchet adapter	Adapter for ITV BLP		ITV	500854	D
	Drill extension Contra-angle, extends by 19 mm			DX2	500704	D
	Universal adapter For all contra-angle instruments Use with ratchet TW2 or RAT 2, max. 30 Ncm			UAW	425107	E

INSTRUMENTS AND TOOLS

	Description	Type	REF	Price cat.
	Ratchet RAT 2	For all Hex instruments and insertion tools	425051	K
	TW2	Torque wrench, 10 - 70 Ncm. For all insertion tools, hex- and torx instruments <i>It is recommended to have the torque ratchets recalibrated by us once a year.</i>	425402	S
	TT 1.25	Torx instrument (for all screws)	425105	C
	TT 1.25 M	Torx instrument (all screws) for contra-angle	425115	C
	HT 1.77	Hex instrument, long	425103	C
	HTX 1.77	Hex instrument, extralong	425104	C
	PUW1	Punch	425404	C

STARTER TRAY



Description	Code	REF	Price €
Adapter contra-angle short	ITV S	500851	
Adapter contra-angle medium	ITV M	500852	
Ratchet adapter for IT V	IT ITV	500854	
Torx instrument	TT 1.25	425105	
Cortical countersink 3.3	CSBL 3.3	900576	
Cortical countersink 4.1	CSBL 4.1	900577	
Cortical countersink 4.8	CSBL 4.8	900578	
Pilot drill	DS 2.0	425001	
Form drill	DBL 2.8	900570	
Form drill	DBL 3.5	900571	
Form drill	DBL 4.0	900572	
Tap	TAP BLP 3.3	900579	
Tap	TAP BLP 4.1	900580	
Tap	TAP BLP 4.8	900581	
Torque wrench	TW2	425402	
Starter tray empty		60045-K	upon request
Starter tray with content		560045-K	upon request

INSTRUMENT TRAY



Description	Code	REF	Price €
Pilot drill	DS 2	425001	
Form drill	DBL 2.8	900570	
Form drill	DBL 3.5	900571	
Form drill	DBL 4.0	900572	
Standardized probe	PDG	425400	
Standardized probe	PDG	425400	
Standardized probe	PDG	425400	
Cortical countersink 3.3	CSBL 3.3	900576	
Cortical countersink 4.1	CSBL 4.1	900577	
Cortical countersink 4.8	CSBL 4.8	900578	
Tap	TAP BLP 3.3	900579	
Tap	TAP BLP 4.1	900580	
Tap	TAP BLP 4.8	900581	
Ratchet adapter for IT V	IT ITV	500854	
Adapter contra-angle short	ITV S	500851	
Adapter contra-angle medium	ITV M	500853	
Adapter contra-angle long	ITV L	500852	
Universal adapter	UAW	425107	
Punch	PUW 1	425404	
Torx instrument	TT 1.25	425105	
Drill extension	DX 2	500704	
Torque wrench	TW2	425402	
Instrument tray empty		60018-K	upon request
Instrument tray with content		560018-K	upon request



(The products of this catalogue are CE marked (class I) and CE 1936 marked (class IIa and IIb) according to 93/42/EC Directive).

Commercial products that are not monitored by our notified body are declared as third-party products.

We are certified DIN EN ISO 13485, and annex II of EEC Directive 93/42 EWG (2007).

Product dimension described in this brochure may differ from reality for technical reasons.

Bone Level Plus® implants are protected by patents. Bone Level Plus® is a registered trademark.

In case that implants would be reprocessed (cleaned, resterilized) infections could occur, because no validated procedures for reprocessing are available.

Compilation and clarification of symbols on the pack:



Batch No.



Sterilized by gamma radiation



Non-sterile



Intended for use by dentists or surgeons only



Single use product



Instruction for use



Expiry date



Store in a dry place



Store tightly keep closed



Do not use if packing is damaged



Do not resterilize



Manufacturer



Production date



Catalogue number



Safely anti-rotational thanks to its internal precision square

Cone technology for a tight seal

Universally suitable for fixed and removable prosthodontics

The cone centers the abutment and provides 100% tightness

IHDEDENTAL 

Dr. Ihde Dental AG
Dorfplatz 11
CH - 8737 Gommiswald / SG
Tel +41 (0)55 293 23 23
contact@implant.com
www.implant.com

Dr. Ihde Dental GmbH
Erfurter Str. 19
D - 85386 Eching / Munich
Tel +49 (0)89 319 761 0
Fax +49 (0)89 319 761 33
info@ihde-dental.de
www.ihde-dental.de